

Power Generation from Coal

Measuring and Reporting
Efficiency Performance
and CO₂ Emissions

Power Generation from Coal

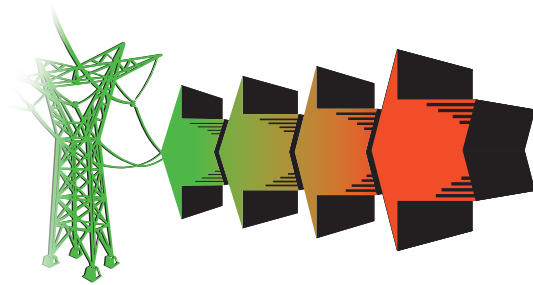

Measuring and Reporting Efficiency Performance and CO₂ Emissions

Coal is the biggest single source of energy for electricity production and its share is growing. The efficiency of converting coal into electricity matters: more efficient power plants use less fuel and emit less climate-damaging carbon dioxide. This book explores how efficiency is measured and reported at coal-fired power plants. With many different methods used to express efficiency performance, it is often difficult to compare plants, even before accounting for any fixed constraints such as coal quality and cooling-water temperature. Practical guidelines are presented that allow the efficiency and emissions of any plant to be reported on a common basis and compared against best practice. A global database of plant performance is proposed that would allow under-performing plants to be identified for improvement. Armed with this information, policy makers would be in a better position to monitor and, if necessary, regulate how coal is used for power generation. The tools and techniques described will be of value to anyone with an interest in the more sustainable use of coal.



Power Generation from Coal

Measuring and Reporting
Efficiency Performance
and CO₂ Emissions

INTERNATIONAL ENERGY AGENCY

The International Energy Agency (IEA), an autonomous agency, was established in November 1974. Its mandate is two-fold: to promote energy security amongst its member countries through collective response to physical disruptions in oil supply and to advise member countries on sound energy policy.

The IEA carries out a comprehensive programme of energy co-operation among 28 advanced economies, each of which is obliged to hold oil stocks equivalent to 90 days of its net imports. The Agency aims to:

- Secure member countries' access to reliable and ample supplies of all forms of energy; in particular, through maintaining effective emergency response capabilities in case of oil supply disruptions.
- Promote sustainable energy policies that spur economic growth and environmental protection in a global context – particularly in terms of reducing greenhouse-gas emissions that contribute to climate change.
- Improve transparency of international markets through collection and analysis of energy data.
 - Support global collaboration on energy technology to secure future energy supplies and mitigate their environmental impact, including through improved energy efficiency and development and deployment of low-carbon technologies.
 - Find solutions to global energy challenges through engagement and dialogue with non-member countries, industry, international organisations and other stakeholders.

IEA member countries:

Australia
Austria
Belgium
Canada
Czech Republic
Denmark
Finland
France
Germany
Greece
Hungary
Ireland
Italy
Japan
Korea (Republic of)
Luxembourg
Netherlands
New Zealand
Norway
Poland
Portugal
Slovak Republic
Spain
Sweden
Switzerland
Turkey
United Kingdom
United States



International
Energy Agency

© OECD/IEA, 2010

International Energy Agency
9 rue de la Fédération
75739 Paris Cedex 15, France

Please note that this publication is subject to specific restrictions that limit its use and distribution. The terms and conditions are available online at www.iea.org/about/copyright.asp

The European Commission also participates in the work of the IEA.

COAL INDUSTRY ADVISORY BOARD

The IEA Coal Industry Advisory Board (CIAB) is a group of high-level executives from coal-related industrial enterprises, established by the IEA in July 1979 to provide advice to the IEA Executive Director on a wide range of issues relating to coal. The CIAB currently has 44 members from 19 countries, contributing valuable experience in the fields of coal production, trading and transportation, electricity generation and other aspects of coal use.

FOREWORD

Coal plays an essential role in our global energy mix, particularly for power generation, but we need to use it efficiently and reduce its environmental footprint. Bringing clarity to the measurement and reporting of efficiency performance and carbon dioxide emissions is a prerequisite to the more sustainable use of coal at power plants. This study by the IEA Coal Industry Advisory Board (CIAB) seeks better ways to measure and report the efficiency of coal use and related emissions. It offers practical advice on a subject that can often appear complex and confusing, but one that is extremely important to assuring coal's role in our energy future, alongside carbon capture and storage.

The recommendation to establish an international database of power plant performance data is welcome. It would be a powerful tool to help identify and target plants where performance can be improved, whether they be in OECD or non-OECD countries. The inefficient use of coal is undesirable and avoidable; it wastes a natural resource and leads to unnecessary pollutant and greenhouse-gas emissions. Moreover, as the world moves to develop and deploy carbon dioxide capture and storage technology, high-efficiency coal-fired power plants will become even more important to compensate for the energy used to capture and compress carbon dioxide for transport and storage.

Through the findings and recommendations in this report, the Coal Industry Advisory Board has made a valuable contribution that will guide policy makers towards better regulation of coal-fired power plants. It is particularly timely given the growth in policies and legislation to curb carbon dioxide emissions in many countries, and the emerging debate on power plant emission performance standards.

Nobuo Tanaka, IEA Executive Director
and

Roger Wicks, IEA Coal Industry Advisory Board Chairman

This report is published under the authority of the IEA Executive Director as part of the IEA role to advise G8 leaders on alternative energy scenarios and strategies. The views and recommendations expressed do not necessarily reflect the view or policies of IEA member countries or of CIAB members and their respective organisations.

ACKNOWLEDGEMENTS

A project to examine coal-fired power plant efficiency and performance was called for in the *Plan of Action* on climate change that was released with the G8 Gleneagles Summit communiqué in July 2005. This report responds to that call, forming part of a work package carried out under the guidance of Neil Hirst, former Director of the Global Energy Dialogue Directorate at the IEA.

The report and its associated appendices, covering efficiency measurement and reporting, were prepared by a working group of the IEA Coal Industry Advisory Board (CIAB) under the leadership of Prof. Allan Jones, Managing Director of E.ON Engineering. Mike Garwood, also of E.ON, was the principal author, while Brian Heath, CIAB Executive Co-ordinator, gave considerable support to the project. Additional inputs were provided by Dr. Colin Henderson of the IEA Clean Coal Centre and from the IEA Secretariat by Dr. Sankar Bhattacharya.

Two IEA committees oversaw the work: the Committee on Energy Research and Technology and the Standing Group on Long-Term Co-operation. Committee members and Energy Advisors from IEA member countries provided ideas and assistance that improved the report. The IEA Working Party on Fossil Fuels gave valuable support, as did participants at a special workshop held in January 2008.* Rebecca Gaghen and her team in the Communication and Information Office at the IEA ensured a publication of the highest quality. Brian Ricketts initiated the project and carried overall editorial responsibility.

Thanks are also due to the following experts for their valuable assistance during the preparation and review of this report: Dr. Seung-Young Chung (KETEP); Aneta Ciszewska (Ministry of Economy, Poland); Stuart Dalton (EPRI); Nataliia Denysenko (IEA); Takashi Iwasaki and Ikuo Nishimura (FEPC); Dipl.-Ing. Hans-Joachim Meier (VGB PowerTech); Elena Virkkala Nekhaev (World Energy Council); and Dr. John Topper (IEA Clean Coal Centre).

Comments and queries regarding this publication should be directed to cleanerfossilfuelsinfo@iea.org.

* www.iea.org/work/workshopdetail.asp?WS_ID=348

TABLE OF CONTENTS

FOREWORD	5
ACKNOWLEDGEMENTS.....	7
EXECUTIVE SUMMARY	13
1. INTRODUCTION	15
• 1.1 Background	15
• 1.2 Objective.....	16
• 1.3 Report structure.....	16
2. FACTORS INFLUENCING POWER PLANT EFFICIENCY AND EMISSIONS.....	17
• 2.1 Differences in reported efficiency values	17
• 2.2 Impact of condenser-operating conditions on efficiency	24
• 2.3 Heat and power equivalence	26
• 2.4 Efficiency performance assessment periods	29
• 2.5 Efficiency standards and monitoring	30
• 2.6 Reporting bases for whole plant efficiency	32
• 2.7 CO ₂ emissions reporting	33
3. GENERIC RECONCILIATION METHODOLOGY	37
• 3.1 Process boundaries	37
• 3.2 Input data requirements.....	40
• 3.3 Output data	41
• 3.4 Generic corrections	45
4. EFFICIENCY OUTLOOK FOR POWER GENERATION FROM COAL	57

5. CONCLUSIONS AND RECOMMENDATIONS.....	61
• 5.1 IEA recommendations to the 2008 G8 Summit.....	61
• 5.2 Reporting efficiency performance.....	62
• 5.3 Improved collection of performance data.....	62
• 5.4 Performance benchmarking.....	63
• 5.5 The way forward.....	63
REFERENCES AND BIBLIOGRAPHY.....	65
ACRONYMS, ABBREVIATIONS AND UNITS.....	69
APPENDIX I: UNDERSTANDING EFFICIENCY IN A POWER STATION CONTEXT.....	75
• Energy supply chain.....	75
• What is efficiency?.....	76
• The vapour power cycle.....	77
• Entropy and the temperature-entropy diagram.....	79
• The Carnot cycle.....	80
• Supercritical steam cycles.....	83
• Rankine and Carnot cycle efficiencies.....	83
APPENDIX II: WORKED EXAMPLE OF EFFICIENCY RECONCILIATION PROCESS.....	85
APPENDIX III: REGIONAL METHODOLOGIES AND DATA SOURCES.....	91
• Australia.....	91
• Canada.....	95
• China.....	96
• Germany.....	97
• India.....	98
• Italy.....	100
• Japan.....	101
• Korea.....	102
• Poland.....	103
• Russia.....	104
• South Africa.....	105
• United Kingdom.....	106
• United States.....	109

List of figures

Figure 2.1	Typical relationship between steam turbine heat consumption and operating load	19
Figure 2.2	Impact of unit operating load on heat rate	20
Figure 2.3	Example energy flows in a typical 500 MW subcritical pulverised coal-fired boiler	24
Figure 2.4	Example of the impact of cooling-water temperature on condenser pressure for constant unit load.....	25
Figure 2.5	Impact of condenser pressure on heat consumption	25
Figure 2.6	Effect of condenser fouling on turbine heat rate	26
Figure 2.7	Effect of heat supply on overall efficiency.....	28
Figure 2.8	Example of relationship between CO ₂ emissions and net plant efficiency (with and without CCS)	35
Figure 3.1	Example of a process boundary showing energy in-flows and out-flows for a power plant	37
Figure 3.2	System boundary for water-steam process.....	38
Figure 3.3	Steam turbine plant test boundary	39
Figure 3.4	Australian GES plant boundary with co-generation	39
Figure 3.5	Comparing plant performance with best practice	43
Figure 3.6	Relationship between coal GCV and as-received moisture content for a large data set.....	46
Figure 3.7	Effect of coal moisture on GCV:NCV ratio for a large data set	46
Figure 3.8	Variation of GCV:NCV ratio with GCV for a large data set	47
Figure 3.9	Dry, ash-free volatile matter as an indicator of carbon: hydrogen ratio for a large data set	48
Figure 3.10	Approximate influence of coal moisture on plant efficiency.....	50
Figure 3.11	Heat rate improvement with main steam and single reheat temperature at different main steam pressures	51
Figure 3.12	Heat rate improvement at different main steam pressure, with increasing main steam and double reheat temperatures	52
Figures 4.1-4.4	Evolution of coal-fired heat and power plant efficiency in selected countries.....	58
Figure 4.5	Efficiency improvement potential at hard coal-fired power plants.....	59

Figure I.1	Typical sequence of events in fuel utilisation	75
Figure I.2	Basic representation of the vapour-power cycle	78
Figure I.3	Temperature-entropy diagram for steam and water	79
Figure I.4	Carnot cycle for steam	80
Figure I.5	Schematic of a simple steam cycle for power generation and associated temperature-entropy diagram	81
Figure I.6	Temperature-entropy diagram with condensed feed water heated by bled steam	82
Figure I.7	Temperature-entropy diagram of a supercritical steam cycle	83

List of tables

Table 3.1	Annual plant operating data requirements	40
Table 3.2	Supplementary data requirements	41
Table 3.3	Template for overall power plant assessment summary	42
Table 3.4	Examples of uncontrollable external constraints and controllable design parameters	42
Table 3.5	General plant information	44
Table 3.6	Typical GCV:NCV ratios for various fuels	48
Table 3.7	Typical carbon:hydrogen ratios for various fuels	49
Table 3.8	Relative carbon-intensity factors for various fuels	49
Table 3.9	Efficiency correction factors for number of reheat stages	52
Table 3.10	Efficiency correction factors for type of cooling system employed	53
Table 3.11	Heat rate correction factors for different gas treatment technologies ..	53
Table I.1	Theoretical Rankine efficiency of different cycle configurations	84
Table II.1	Annual "as-run" data from operator	85
Table II.2	Information that can be derived from the "as-run" data in Table II.1 ..	86
Table II.3	Supplementary data from operator that can help detailed calculation of plant performance	87
Table II.4	Basic unit data required to calculate correction factors	88
Table II.5	Calculated efficiency correction factors for the "case-study" plant	89
Table II.6	Efficiency correction factors for reference plant	89
Table II.7	Overall power plant assessment summary	90

EXECUTIVE SUMMARY

Coal-fired power plants, also known as power stations, provide over 42% of global electricity supply. At the same time, these plants account for over 28% of global carbon dioxide (CO₂) emissions. This report responds to a request to the IEA from G8 leaders in their *Plan of Action* on climate change, clean energy and sustainable development, issued alongside the G8 Gleneagles Summit communiqué in July 2005. The G8 requested a review and assessment of information on the energy efficiency of coal-fired power generation. This report reviews the methods used to calculate and express coal-fired power plant efficiency and CO₂ emissions, and proposes a means to reconcile differences between these methods so that comparisons can be made on a common basis. With a clearer understanding of power plant efficiency and how to benchmark this performance measure, policy makers would be in a better position to encourage improvements in power plant performance.

An essential part of sound policy development is the rigorous analysis of information which should be internally consistent and verifiable. Reliable power plant operating information is not easy to obtain, whether for an individual unit or for a number of units comprising a power plant, particularly efficiency-related information such as coal quality, coal consumption and electricity output. It is therefore proposed that an international database of operating information for units at coal-fired power plants should be established for the purposes of determining, monitoring, reporting, comparing and projecting coal-fired power plant efficiencies and specific CO₂ emissions on an annual basis. Such a database of individual units could be maintained by the IEA through its Energy Statistics Division or by the IEA Clean Coal Centre Implementing Agreement as an extension of its existing CoalPower5 database of world coal-fired power plants.

At present, there is no common standard for collecting and compiling coal-fired power plant efficiency or CO₂ emissions data; many different bases and assumptions are used around the world. Defining a common methodology to rationalise efficiency reporting is not a practical proposition. Instead, approximate corrections are proposed, requiring only limited information that can be collected even where the detailed bases of the original calculations are not known. Average figures, reported for periods of a month or more, will be inherently more reliable, reflecting the actual efficiency achieved more accurately than design values, performance guarantees or results from short-term tests under ideal conditions. The corrected data can then be compared with one another and to reference data sets reflecting best practices.

CO₂ capture and storage, once adopted, will impact significantly on the efficiency of both existing and future plants. At the current state of technology, units retrofitted with CO₂ capture would suffer a decrease in efficiency of up to 12 percentage points, and consume perhaps 20% to 30% more fuel per unit of electricity supplied. While a concept of what constitutes “capture-ready” exists for new power plants, it may not be economic or technically viable to retrofit existing plants with CO₂ capture, especially at smaller inefficient units. Refurbishments will often be necessary to improve efficiency at existing plants before CO₂ capture retrofit can be contemplated.

Policy makers must reflect on what steps are now needed to improve the overall efficiency of power generation from coal. This report presents the tools for analysis and makes recommendations on how to use these tools to compare performance. This will allow poorly performing plants to be identified, wherever they are located. The costs and benefits of refurbishing, upgrading or replacing these plants can be estimated as the first stage in developing new policies that would encourage greater efficiency. The prize is large; some estimates suggest that 1.7 GtCO₂ could be saved annually. However, securing this reward would demand a major realignment of national energy and environmental policies, a realignment that may be less politically acceptable than allowing old, inefficient coal-fired power plants to continue running, in the hope that they will eventually fade away. Given that there currently appears to be no prospect of meeting global electricity demand without coal, governments must implement policies that respond more proactively to the growing use of coal, rather than wishing it away. Monitoring the efficiency of power plants and targeting those that perform poorly would be an important step in that direction.

1. INTRODUCTION

1.1 Background

Coal is the world's most abundant and widely distributed fossil fuel with reserves for all types of coal estimated to be about 990 billion tonnes, enough for 150 years at current consumption (BGR, 2009).¹ Coal fuels 42% of global electricity production, and is likely to remain a key component of the fuel mix for power generation to meet electricity demand, especially the growing demand in developing countries. To maximise the utility of coal use in power generation, plant efficiency is an important performance parameter. Efficiency improvements have several benefits:

- prolonging the life of coal reserves and resources by reducing consumption;
- reducing emissions of carbon dioxide (CO₂) and conventional pollutants;²
- increasing the power output from a given size of unit; and
- potentially reducing operating costs.

The calculation of coal-fired power plant efficiency is not as simple as it may seem. Plant efficiency values from different plants in different regions are often calculated and expressed on different bases, and using different assumptions. There is no definitive methodology.³

In their 2005 *Plan of Action* on climate change, clean energy and sustainable development, agreed at the Gleneagles Summit in 2005, G8 leaders addressed this topic (G8, 2005):

“We will support efforts to make electricity generation from coal and other fossil fuels cleaner and more efficient by: (a) supporting IEA work in major coal using economies to review, assess and disseminate widely information on energy efficiency of coal fired power plants; and to recommend options to make best practice more accessible.”

Their commitment provided a sound basis for a review of how power plant efficiency data are prepared, disseminated and used, including how different methods can be reconciled. A better understanding of power plant efficiency leads quickly to the question of how it might be improved through further development and dissemination of technologies that are not yet widely deployed.

1 Quantity that is estimated to be economically recoverable using current mining techniques.

2 A one percentage point improvement in efficiency can result in a 2.5 percentage points reduction in CO₂ emissions.

3 For example, the heat rate of European power plants can appear to be 8%-10% lower than their US counterparts (and so appear 3-4 percentage points more efficient). This may be partly due to real plant differences, but differences between calculation methodologies for identical plants can also be of this magnitude.

1.2 Objective

Measuring coal-fired power plant efficiency consistently is particularly important at the global level, yet significant regional differences exist. Similarly, at the local level, the performance of individual generating units and power plants can only be compared if measured consistently. Although variations in efficiency may arise from differences in plant design and maintenance practices, the practical and operational constraints associated with different fuel sources, local ambient conditions and electricity dispatch all play significant roles. Misunderstanding these factors can result in the misinterpretation of efficiency data.

Thus, reconciling different efficiency measurement methodologies is not simply concerned with theoretical design efficiency, but with the actual operational efficiency of existing power plants and all the associated issues and constraints found in the real world.

This study proposes a generic methodology which can be applied to determine the efficiency and specific CO₂ emissions of coal-fired power generation processes. The application of such a reference methodology would provide a potential route to gauge how coal might be deployed more cleanly and efficiently in the future. To this end, the major objective of this report is to review the methods used to calculate and express coal-fired power plant efficiency and CO₂ emissions, and determine whether these can be reconciled for comparison using a common basis.

The target audience for this report includes technical decision makers in industry and policy makers in government who must master the details of efficiency measurement if they are to effectively manage and regulate power plants. Early conclusions from this report guided IEA policy recommendations on cleaner fossil fuels presented to the G8 Hokkaido Summit in 2008 (IEA, 2008).

1.3 Report structure

Section 2 explores, in some technical detail, those aspects of power plant design, monitoring and operation that can influence efficiency measurement and comparison. A generic methodology is prescribed in Section 3 to adjust reported data and reconcile efficiencies reported on different bases. Section 4 briefly looks at historic and likely future trends in power plant efficiency. Section 5 summarises recommendations made by the IEA at the G8 Hokkaido Summit and makes further recommendations to implement the methodology and compile a database of efficiency data that would allow the performance of power plants to be contrasted and compared. Appendices support the main report with additional technical background, an example efficiency calculation and accounts of how power plant efficiency and emissions are measured and reported in a number of different IEA member and non-member countries, all being large users of coal for power generation.

2. FACTORS INFLUENCING POWER PLANT EFFICIENCY AND EMISSIONS

This section explores aspects of power plant design and operation that influence efficiency performance. It focuses on practical issues; to aid understanding of the discussion, some theoretical aspects of power plant efficiency are set out in Appendix I. The section also reviews the relevance of current power plant performance measurement standards and how these might be reconciled using a common methodology to allow performance benchmarking. The section continues with a summary of the reporting bases and the required information sources for calculating the efficiency of a whole plant according to national standards. CO₂ emissions from fossil fuel use are closely related to plant efficiency and the section concludes with a review of how these are monitored and reported in practice.

2.1 Differences in reported efficiency values

Apparent efficiency differences

Differences in reported efficiencies between plants can sometimes be artificial, and not reflective of any underlying differences in their actual efficiencies. The reported efficiency of two identical plants, or even the same plant tested twice, could potentially be different owing to:

- the use of different assessment procedures and standards;
- the use of different plant boundaries and boundary conditions;
- the implementation of different assumptions or agreed values within the scope of a test standard;
- the use of different operating conditions during tests;
- the use of correction factors to normalise test results before reporting;
- the expression of results on different bases (*e.g.* gross or net inputs and outputs);
- different methods and reference temperatures for determination of fuel calorific value (CV);
- the application of measurement tolerances to the reported figures;
- differences in the duration of assessments;
- differences in the timing of assessments within the normal repair and maintenance cycle;
- errors in measurement, data collection and processing; and
- random performance and measurement effects.

These effects are difficult to quantify, especially when assessing the performance of major sub-systems that are interconnected with other parts of the plant.

Gross and net values

Assessments of efficiency often refer to “gross” or “net” bases, both for the determination of the heating values of fuel inputs and for the energy outputs from a process. In the latter case, the terminology usually relates to the use of a proportion of the output energy by the process itself: the output being referred to as “gross output” before any deduction, or “net output” after the deduction for own-use. This most commonly applies to the consumption of electrical power by a plant where “generated” power is referred to as “gross output”, and “sent-out” power, following deduction of on-site power use, is referred to as “net output” or “gross-net”. This analysis can be complicated further for multi-unit sites where some parts of the process may be fed directly from a common import power supply, shared between all generating units. This power must also be deducted from generated power to derive a true “net output” for the plant; an output that may be referred to as “gross-net-net” or “station net export”.

For fuels, the difference between gross calorific value (GCV) and net calorific value (NCV) stems from the assumptions made about the availability of the energy present in the moisture in the combustion products.⁴ The GCV measures all the heat released from fuel combustion, with the products being cooled back to the temperature of the original sample. In the NCV assessment, it is assumed that water in the combustion products is not condensed, so latent heat is not recovered. Using the NCV basis is questionable: a modern condensing boiler could potentially achieve a heating efficiency in excess of 100%, in violation of the first law of thermodynamics. Although some regions and industries prefer to use lower heating values in daily business, the true energy content of a fuel is its GCV or higher heating value. Another complication, associated with fuel heating values, is the reference temperature used for their determination. Typically, calorific values are quoted based on a 25 °C reference temperature; however, 15 °C is also commonly used and other temperatures may be used after correction, if these differ from the temperature of the reactants and products at the start and end of the combustion test. Obviously, the use of values calculated on different reference temperature bases would result in different apparent heat inputs. Some technical standards provide equations for the correction of calorific values between different reference temperatures.

Electrical power imports and exports

Electricity produced and consumed within the plant should not affect plant performance assessment, providing the system boundary is drawn at the outer plant boundary. Electrical power imported into the plant can be deducted directly from exported power in order to calculate the overall net power generation for efficiency assessment. In general, it is recognised that power exports should be referenced to the conditions at the transmission side of the generator transformer and thus account for transformer losses.

Efficiency differences due to real constraints

It is reasonable to expect that there will be differences in efficiency between particular plants because of the constraints within which they were constructed and operate. Considerations which can impact significantly on efficiency include:

- fuel moisture content (influences latent and sensible heat losses);⁵
- fuel ash content (impacts on heat transfer and auxiliary plant load);
- fuel sulphur content (sets design limits on boiler flue gas discharge temperature);
- use of closed-circuit, once-through or coastal cooling-water systems (determines cooling-water temperature);
- normal ambient air temperature and humidity;

⁴ GCV is also known as higher heating value (HHV), while NCV is also known as lower heating value (LHV). GCV measures a fuel's heat of combustion assuming all water in the flue gas is condensed; NCV excludes this latent heat.

⁵ Latent heat is absorbed or released during a change of state with no change in temperature, *e.g.* boiling a liquid to a gas, or condensing a gas; sensible heat is associated with changes in temperature, *e.g.* superheating steam.

- use of flue gas cleaning technologies, *e.g.* selective catalytic reduction (SCR), fabric filtration, flue gas desulphurisation (FGD) and CO₂ capture (all increase on-site power demand); and
- use of low-NO_x combustion systems (requires excess combustion air and increases unburned carbon).

A plant designed for high-moisture, high-ash coal, fitted with FGD and bag filters, and operating with a closed-circuit cooling system, for example, could not be expected to achieve the same efficiency as one without FGD using high-rank, low-ash, low-moisture bituminous coal at a coastal site with cold seawater cooling. In most cases, there is little that can be done to mitigate these effects; it is sufficient to recognise that their impact is not necessarily a result of ineffective design or operation, but merely a function of real plant design constraints.

It might be argued that the major fuel factors – the first three bullet points above – are not genuine constraints since, in many cases, fuels can be switched, blended or dried. The commercial feasibility of doing this will depend partly on the availability of fuels and partly on the cost and practicality of purchasing and transporting these to the plant. Coastal power plants may have more fuel supply alternatives than inland power plants close to local coal resources. Another obvious consideration is the environmental impact of transporting fuel over longer distances.

Efficiency differences in operation

Efficiency is significantly affected when plants operate under off-design conditions, particularly part-load operation.

Average operating load

Plants which operate with a low average output will return low efficiencies compared to their full-load design efficiency. Steam turbine heat consumption is characterised by a relationship known as the “Willans line”, shown in Figure 2.1 for an example turbine. This line shows that total heat consumption comprises a fixed element and an incremental element: at zero load, the heat consumption is not zero. This relationship is normally derived by undertaking a number of heat consumption tests on a turbine at different loads and then plotting a best-fit line through the observed values.

Figure 2.1: Typical relationship between steam turbine heat consumption and operating load

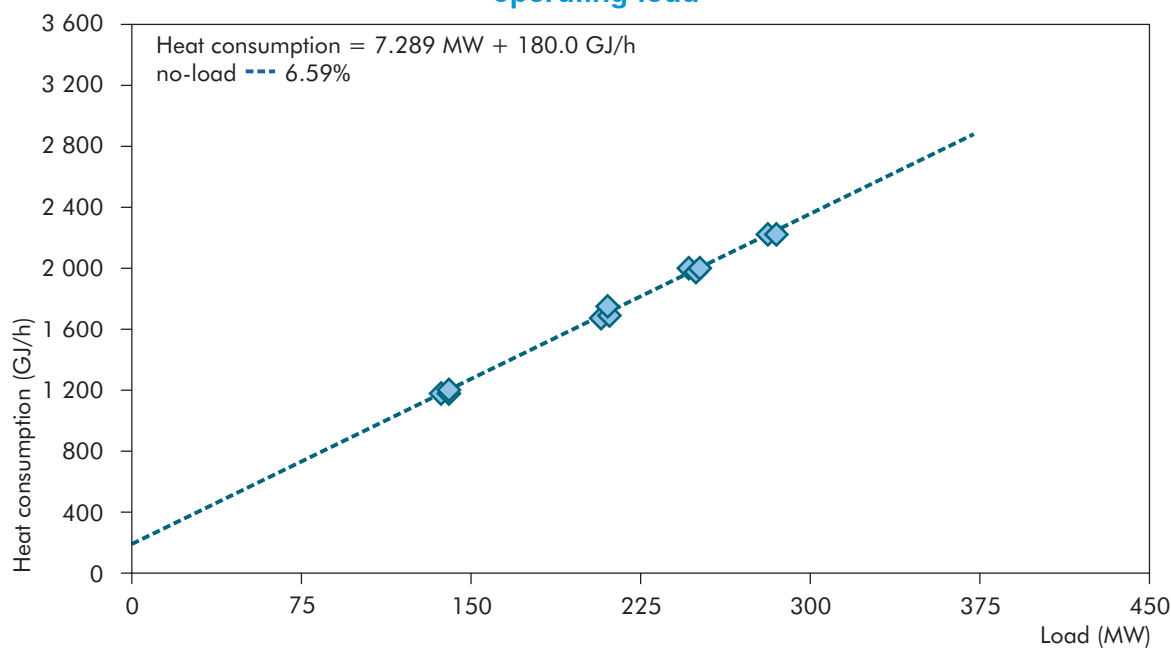

Source: Gill (1984). Reprinted by permission of the publisher. © Elsevier, 1984.

The overall energy consumption of a plant can be similarly characterised by a fixed element and a variable element proportional to output. Hence, overall efficiency will decline as load is reduced and the no-load portion becomes a greater fraction of the total heat.

Another related consideration is that works power⁶ will account for a greater percentage of generated power at part load, because the no-load running losses of electrical equipment increase relative to useful output and because certain activities must be carried out, irrespective of unit load.

For these reasons, power plants may formally record “part-load loss” as a penalty incurred purely as a result of being asked to operate the plant at a lower-than-optimum output.

Figure 2.2, derived from the Willans line and assuming an overall unit fixed heat rate of 9% (*i.e.* greater than the turbine-only fixed heat rate), illustrates the effect of running at lower loads on the performance of subcritical and supercritical units. Supercritical units are shown to experience only about half the part-load efficiency degradation of a conventional subcritical unit.

Figure 2.2: Impact of unit operating load on heat rate

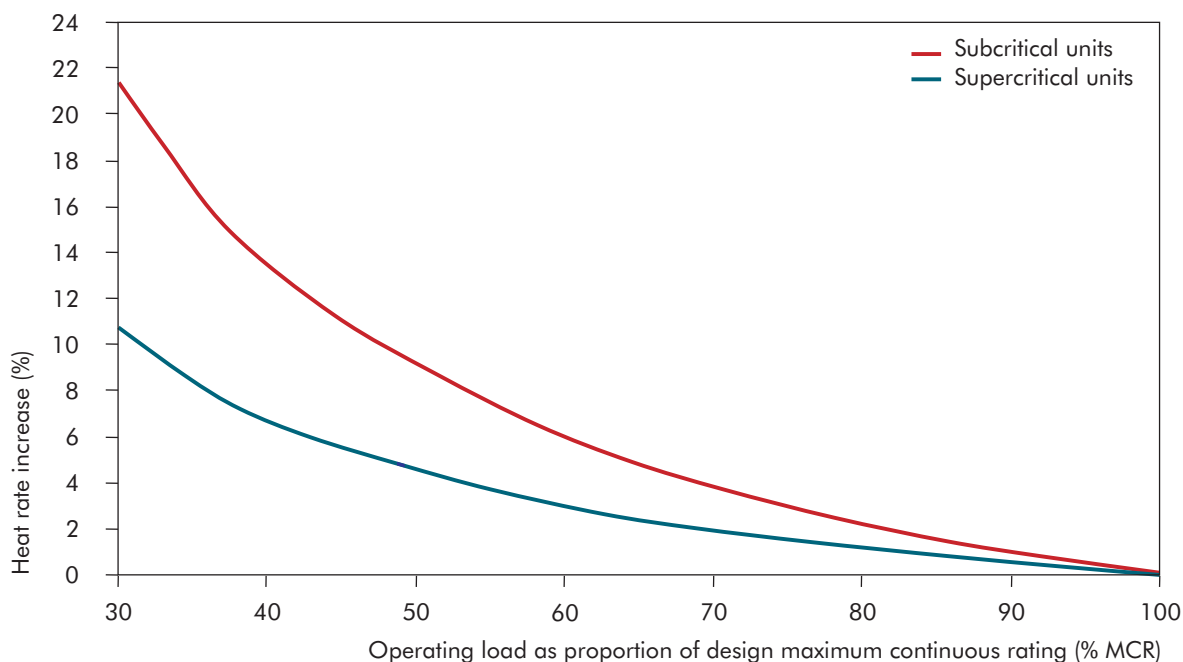

Source: E.ON UK plc.

Load factor

The effects of average operating load (see above) and load factor are different. Load or capacity factor describes the output over a period of time relative to the potential maximum; it depends on both running time and average operating load. It is not necessary to consider load factor specifically here since the impacts of more frequent unit starts or lower operating unit loads can be taken into account separately. It is technically possible for a low load factor plant to attain high efficiency if starts are few in number and the load is kept high during the periods of generation. However, there may be practical issues relating to system power demand and management which preclude operation in this way.

⁶ “Works power” is the electricity used on a power plant site, principally to power motors that drive pumps, fans, compressors and coal mills.

Transient operation

Another factor which can significantly impact efficiency is the number of perturbations (transients) from steady state operating conditions. During each of these transients, the plant will not be operating at peak performance: the more transients, the greater the reduction in efficiency. Operation in frequency response mode, where steam flow and boiler firing fluctuate to regulate system frequency, can lead to more transients. Other situations may require frequent load changes, notably in response to power system constraints or power market pricing.

Plant starts

An extreme form of transient operation is where demand falls sufficiently to require plant shutdown. This incurs significant off-load energy losses, particularly during subsequent plant start-up, which must be done gradually to avoid damage from thermal stresses. While the plant is not generating output, all of the input energy is lost (*i.e.* efficiency is 0%). Supercritical units, in particular, have high start-up losses because large quantities of steam, and therefore heat energy, must be dumped to the condenser during start-up.

Power plants operating in volatile or competitive markets, or operating as marginal providers of power, may be required to shut down frequently. This can, in turn, lead to a deterioration in physical condition which will affect plant efficiency. For base-load operation, unit start-up energy may be a negligible fraction of total energy (<0.5%). For other flexibly operated plant it could represent 5% or more of total energy consumed and result in reductions in efficiency in the order of 2 percentage points, even if the average output during the on-load period is high. For simplicity, corrections of 0.5%, 1.5% and 5% of total energy use could be applied to plant running regimes categorised as “base-load”, “transitional” and “marginal/peaking”.

Performance optimisation

The adoption of good practices and exercise of care will avoid most operational problems within the control of a plant operator. Although the majority of operational efficiency variations are linked to unit load and the need to operate through transient conditions, there is usually some scope for final optimisation of performance by fine tuning of automatic controller set points and control loops, amounting to about 1% of a unit’s heat rate. Optimisation may be performed manually or through the use of advanced control systems or optimisers, some of which are based on neural networks. Operator experience can also be a source of operational gains or losses. The commercial attractiveness of performance optimisation increases with plant load and can be substantial at high loads. Optimisation is a potentially attractive proposition at any load where the plant will be operated for a significant period of time.

Boiler operation is an area where efficiency gains are often possible. A “fixed-pressure” boiler requires the outlet steam to be throttled at part load to match the lower pressure demand of the turbine. “Sliding-pressure” boiler designs avoid this loss, with the added benefit that feed-water pumps require less power. Sliding-pressure control is standard operating procedure on most modern power plants.

Control systems play a major part in optimisation by enabling the automation of best practices. The use of advanced control systems can bring about significant efficiency improvements and reduce CO₂ emissions.

Regulation

The regulatory environment can have a significant impact on power plant operation and efficiency. Meeting the requirements of environmental emissions legislation, even where flexible with respect to operating regime and fuel quality, can be a challenge to operators. In some cases, achieving multiple objectives simultaneously can impact efficiency since transients, off-design fuels and emission controls generally add to energy losses. Functional performance, for example to achieve target output, load ramp rates or frequency control, may be a higher priority to the plant operator than efficiency optimisation. Where a plant operates within a competitive market environment, making the case for investment in plant maintenance and upgrades to improve performance and efficiency may be more difficult because operating margins may be slim, and market volatility may hinder long-term investment planning.

Efficiency differences due to design and maintenance

For the same operating regime and boundary conditions, any remaining differences in efficiency are largely down to the basic design of the plant and how well it is maintained. Overall performance is generally a function of both individual component design efficiencies and process integration. Lower levels of performance can be expected from plants of older design, although upgrades can improve even the oldest plants.

Plant design

The adoption of supercritical (SC) and ultra-supercritical (USC) steam conditions for new generating plants, in conjunction with modern steam turbine designs, has been key to improved design efficiency.⁷ Newer plant designs may also incorporate steam temperature attemperation control, which results in lower steam-cycle losses, and better control and optimisation features.

Comparisons of best practice are generally confined to this area since factors such as plant operating regime, fuel quality and local ambient conditions are largely beyond the control of the plant owner and operator.

Deterioration

Taking turbine efficiency as an example, deterioration over the first year of operation could be relatively rapid, but will then slow. Deterioration may be the equivalent of 0.25% of heat consumption per year of operation between overhauls, but with up to 2% lost in the first two years alone. This reduction in turbine efficiency will be reflected in overall plant performance. Some, but not all, of the deterioration will be recovered by routine maintenance. Generally, plant performance will be restored during major overhauls. However, the extent of repair and refurbishment work, and the ensuing efficiency benefits, is a commercial decision for the operator.

Plant maintenance

The actual performance of a plant compared to its design and “as-commissioned” performance is crucial. As equipment wears, fouls, corrodes, distorts and leaks, as sensors and instrumentation fail, and as calibrations drift, the plant tends to become less efficient. As well as ensuring integrity, a key requirement of plant maintenance is to maintain peak efficiency. Improved maintenance and component replacement and upgrading can reduce energy losses.

In addition to restoring performance lost through in-service deterioration, plant maintenance and overhaul activities represent an opportunity to retrofit more modern components with improved performance. Where plant designs have improved since original plant commissioning, the combination of performance restoration and plant modernisation can lead to substantial improvements in efficiency and often to greater generating capacity.

In practice, any poorly performing auxiliary equipment or individual components (*e.g.* fans, pumps, heat exchangers, vent and isolation valves, gearboxes, leaking flanges and even missing or inadequate insulation) contribute to the overall deterioration of plant performance over time, compounding the effects of deterioration in major components, such as the steam turbine. Significant deterioration can also occur in the steam turbine condenser or cooling-water system, where progressive increases in air ingress and steam- and water-side fouling or corrosion can degrade heat transfer. Cooling tower performance is an important consideration in this respect.

Component availability

Efficiency can be reduced by the non-availability of certain items of plant and equipment including:

- main condenser cooling-water pumps and condenser tube banks;

⁷ Subcritical, supercritical and ultra-supercritical are engineering terms relating to boiler temperature and pressure conditions (see Appendix I).

- cooling towers;
- on-load condenser cleaning equipment;
- condenser air extraction plant;
- boiler feed-water pump turbine and feed-water heaters;
- reserve coal milling plant capacity;
- feed-water heater drains pumps (resulting in diversion of drains to the condenser); and
- boiler soot blowers.

Maintaining cleanliness is important to avoid heat transfer degradation in boilers, condensers and cooling-tower systems. Accumulated deposits in a steam condenser will result in higher turbine backpressure; in tubular feed-water heaters, they will increase terminal temperature difference; and in the boiler, they will increase gas exit temperatures. For the boiler in particular, the lack of availability of individual soot blowers can lead to severe deposit formation which can affect the combustion process, and cause erosion and thermal-stress damage. In bad cases, such deposits can force unit de-rating or even plant shutdowns. Even in cases with no forced outage, an increase in planned outages and internal cleaning costs may still be incurred.

Abnormal operating conditions brought about by faulty instrumentation or equipment can result in significant efficiency losses which will accumulate if left uncorrected. Failed valve actuators, missing indicators and out-of-tune control loops can leave units operating with some equipment out of service, or with restricted control facilities and flexibility.

Energy and efficiency losses

The transfer of heat energy to the working fluid of the power cycle can never be complete or perfect. The presence of tube wall and refractory material (if used), surface deposits and non-ideal flow regimes all impede heat transfer. In the case of a coal-fired boiler, the net result of these imperfect conditions is a degree of heat loss from the hot source (burning coal) in the form of hot flue gases. In cases where condensation has to be avoided, and particularly where the acid dew point temperature is raised because of the presence of sulphur, chlorine or excessive moisture in the fuel, the hot flue gases loss can be significant. Auxiliary equipment consumes energy, *e.g.* coal mills, water pumps, fans and soot blowers for cleaning heat transfer surfaces. Some heat is also lost to the surroundings through conduction, convection and radiation of heat, even where equipment is insulated. The turbo-alternator plant similarly has losses which reduce performance compared to the ideal, and although efforts are made to minimise these, there are economic and practical limits to what can be achieved.

In summary, the plant will have losses associated with:

- combustor flue gas wet and dry gas losses and unburned gas heating value;
- combustor solid residue sensible heat content and unburned fuel heating value;
- heated water or steam venting and leaks, and other drainage and blow-down;
- frictional losses, radiated and convected heat;
- cooling system losses where heat is rejected and not recovered;
- heat lost to flue gas treatment reagents and energy consumed by fans in overcoming gas pressure drops;
- make-up and purge water;
- off-load losses associated with start-up and shutdown;
- off-design losses associated with transient operation and part-load running; and
- transformer losses.

2.2 Impact of condenser-operating conditions on efficiency

The Sankey diagram in Figure 2.3 shows example heat flows in a typical 500 MW subcritical pulverised coal-fired boiler, where the electrical output is 39% of the heat input and the heat rejected by the condenser to the cooling water is 52.5%. This example illustrates that it is the thermodynamics of the steam cycle, and not the fuel combustion process, which is a limiting factor for conventional power plant efficiency. Where the rejected heat can be utilised, this can provide significant improvements to the overall cycle efficiency.

Figure 2.3: Example energy flows in a typical 500 MW subcritical pulverised coal-fired boiler

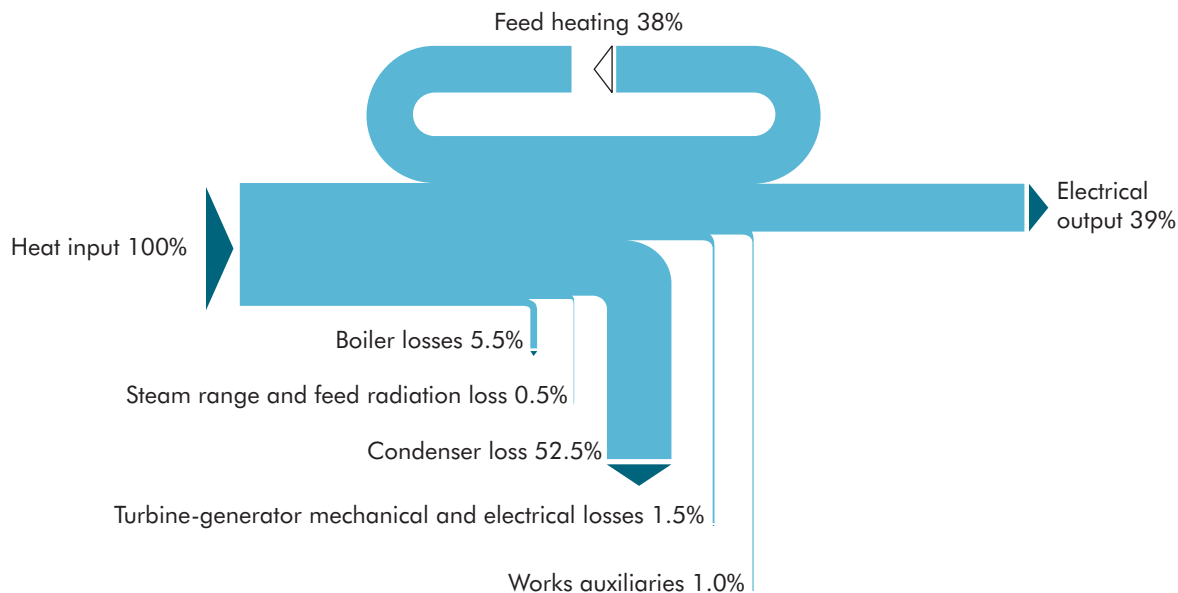

Source: White (1991). Reprinted by permission of the publisher. © Elsevier, 1991.

A relatively small change in condenser pressure, in the order of thousandths of a bar (or hundreds of pascals), can bring about seemingly disproportionately large changes in plant efficiency. To achieve similar changes in efficiency at the high-temperature end of the cycle would require more significant changes in steam conditions. A major factor governing the condenser pressure is the availability of a cold heat sink for heat rejection. This is often provided in the form of a large body of water such as the sea or a river, although heat can also be rejected using closed-circuit wet, semi-dry or dry cooling systems. The temperature and quantity of cooling medium available to the condenser have a significant impact on performance. Since economics generally determine the heat exchanger size, and the capacity of the cooling system, a major factor determining real plant performance becomes the cooling-water supply temperature to the condenser. This tends to be lowest for coastal sites in the northern hemisphere and highest for sites in locations with high ambient temperatures and limited water supplies.

The precise impacts of cooling-water temperature on condenser pressure, and the associated impact of condenser pressure on heat rate, are site-specific. Like many of the other losses considered in this report, a detailed thermodynamic model in conjunction with real plant operating experience should be used to assess site specific losses. However, within reasonable limits, some approximations can be made. In general, the impact of cooling-water temperature on condenser pressure is about 2 mbar per 1 °C change in inlet temperature, and the associated impact on heat rate is in the order of 0.1% of station heat consumption per 1 mbar. Thus a difference of 5° C in cooling water inlet temperature might change unit heat consumption by around 1%.

Ambient conditions change both seasonally and diurnally. In the case of a closed-circuit cooling system, there will be feedback effects from the load on other units which may be using the same cooling system. These all affect heat consumption. Examples of the impact of cooling-water temperature on condenser pressure and the impact of condenser pressure on heat consumption in conventional steam plants are shown in Figures 2.4 and 2.5.

Figure 2.4: Example of the impact of cooling-water temperature on condenser pressure for constant unit load

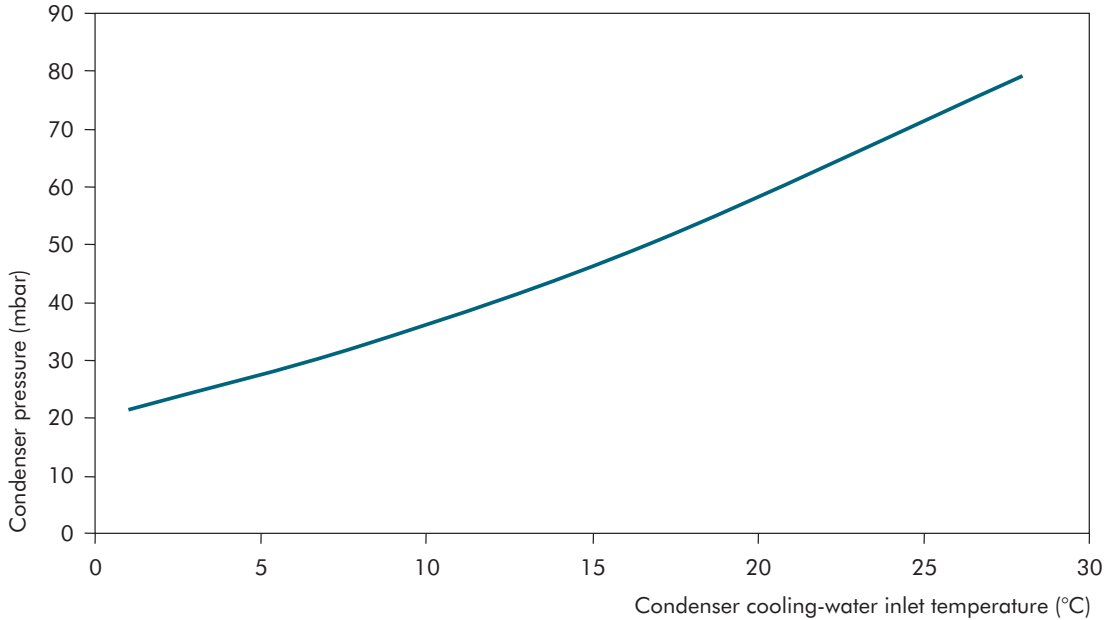

Source: E.ON UK plc.

Figure 2.5: Impact of condenser pressure on heat consumption

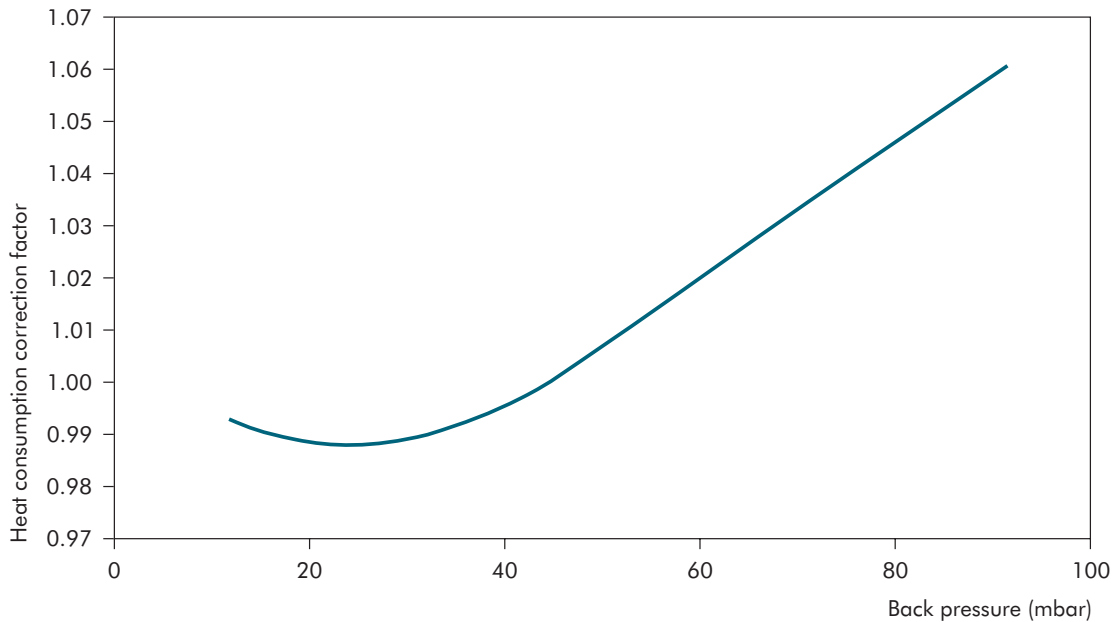

Source: Gill (1984). Reprinted by permission of the publisher. © Elsevier, 1984.

Maintaining a low condenser pressure is clearly important. However, power plant condensers tend to suffer from degradation in performance over time because of scaling and fouling, as well as any loss of area due to the removal from service of damaged elements (usually by sealing). Although periodic physical cleaning is usually performed, and some stations have on-load cleaning systems, performance still varies according to the state of cleanliness. Figure 2.6 illustrates the effect of condenser cleanliness on heat consumption.

Figure 2.6: Effect of condenser fouling on turbine heat rate

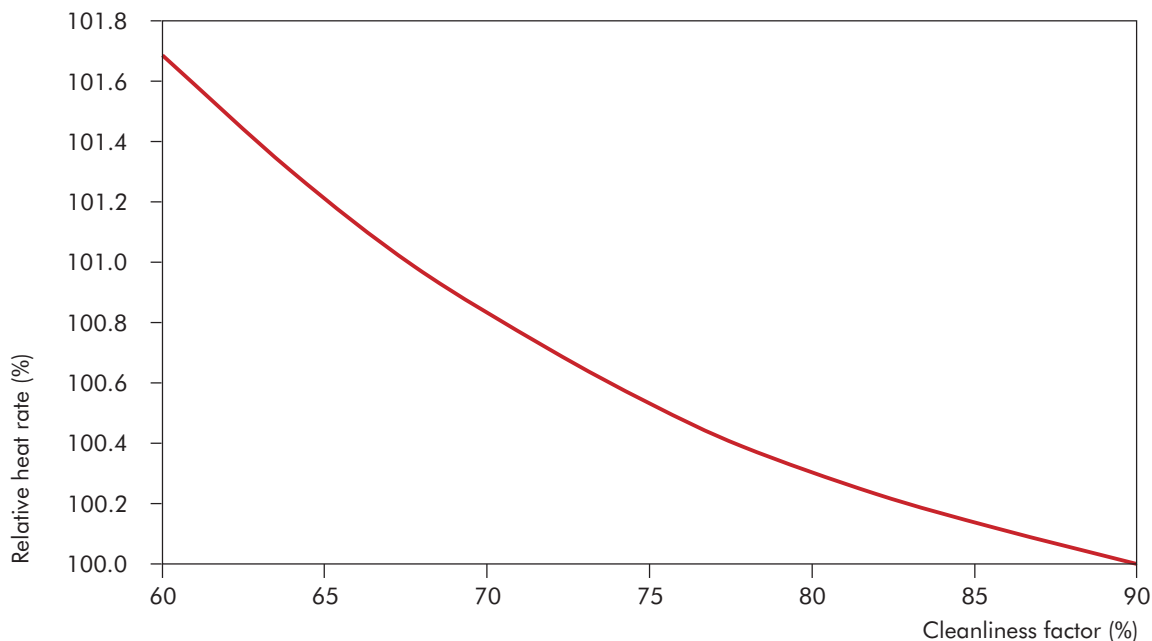

Source: AGO (2006). Reprinted by permission of the publisher. © Department of Climate Change and Energy Efficiency, 2006.

Steam cycle efficiency can be improved by extending the working temperature range through the addition of “topping” or “bottoming” cycles. In the topping cycle, a gas turbine is employed, where the working fluid is hot gases at a higher temperature than steam in a steam turbine, and exhaust heat is used in the boiler of a Rankine steam cycle. In a bottoming cycle, refrigerant-type fluids can be used to accept the heat rejected from the Rankine cycle and do more work in a separate turbine or expander designed for the lower temperature gas. Neither option is commonly employed in coal-fired electricity generating plant, although a combined cycle gas turbine plant is effectively a topping cycle with a Rankine cycle, albeit with no direct firing of the heat recovery boiler.

2.3 Heat and power equivalence

Both heat and electrical power are forms of energy and can therefore be measured using the same engineering units. Energy conversion processes themselves can only convert heat into power with a certain efficiency; losses mean that electric power requires more primary energy than heat, making electricity more valuable. Although net power and net heat outputs can be calculated separately, the equivalence between power and heat requires careful consideration. Heat use, in particular, can be a very important factor in efficient coal energy utilisation and specific CO₂ emissions.

Plants supplying both heat and power have an overall plant energy efficiency that can be calculated by taking into account both the heat and power outputs from the process. While it is also possible to calculate effective

efficiencies for heat and power production independently, these values may have less meaning and require more interpretation. For example, the heat output can be used as a fuel heat rate correction to yield a net heat flow used for electricity generation.

In the case of a power production process where rejected heat is not utilised, as in most utility-scale plants, the total fuel energy input is used to produce electrical power with a given efficiency. If the waste heat was recovered and used, it could be argued that the heat was not produced specifically to meet demand, the efficiency of its production might be considered to be 100%. The use of some of this otherwise waste heat now brings about an apparent increase in plant electrical efficiency, even though nothing in the basic power production process has changed. If, however, the waste heat utilisation was excluded from the power generation efficiency, then this would not reflect the energy efficiency benefits of combined heat and power.

Some standards and protocols suggest that heat and power generation efficiencies should be calculated separately and each referred to the total energy input (usually input fuel energy, but may also include power and heat energy from other sources) as follows:

$$\text{power generation efficiency} = \frac{\text{output power energy}}{\text{total energy input}}$$

$$\text{heat generation efficiency} = \frac{\text{output heat energy}}{\text{total energy input}}$$

This provides one method of determining efficiency, although the results may be misleading. If some or all of the rejected heat from power generation is used to satisfy a heat demand, and therefore offset other energy use, this is not recognised in the power generation efficiency calculation. It is proposed that heat rejected from the steam cycle which is recovered and put to use is not considered as consumed by the power process, or treated as a loss, but is instead treated as energy supplied to the heat system.

The overall energy efficiency of the plant can then take account of power and heat export, as applicable:

$$\text{plant efficiency} = \frac{(\text{output power energy} + \text{output heat energy})}{\text{total energy input}}$$

The apparent electrical efficiency can be determined by debiting any heat energy output from the total input energy. In other words, any useful energy output, other than electricity, effectively reduces the energy attributed to the generation process. For example, consider a plant with a fuel energy input of 500 GJ producing power with an energy equivalent of 200 GJ (56 MWh). The overall plant efficiency equals the power generation efficiency, because there is no heat output:

$$\text{power generation efficiency} = \frac{200}{500} = 40.0\%$$

If 150 GJ of the waste heat is used, then the overall plant efficiency increases:

$$\text{overall plant efficiency} = \frac{200 + 150}{500} = 70.0\%$$

The apparent electrical or power generation efficiency is now:

$$\text{power generation efficiency} = \frac{200}{500 - 150} = 57.1\%$$

Similar analysis can be used to calculate the efficiency of heat production:

$$\text{heat generation efficiency} = \frac{150}{500 - 200} = 50.0\%$$

This method of analysis, although not perfect, is a practical means of calculating and comparing real plant efficiencies. In the above example, the heat generation efficiency is low compared to the efficiency of a modern heating boiler. However, the use of waste heat improves the effective efficiency of the power generation process and the overall energy efficiency. It should be noted that the overall efficiency is not the simple numerical sum of the power and heat efficiencies.

The simplicity of this calculation enables the output heat energy to be used directly as a correction factor to the overall efficiency figure of a combined heat and power plant. Figure 2.7 shows a generic correction factor which can provide corrections for a range of plant types. It should not be used to determine or correct the independent heat-only or power-only efficiencies.

Figure 2.7: Effect of heat supply on overall efficiency

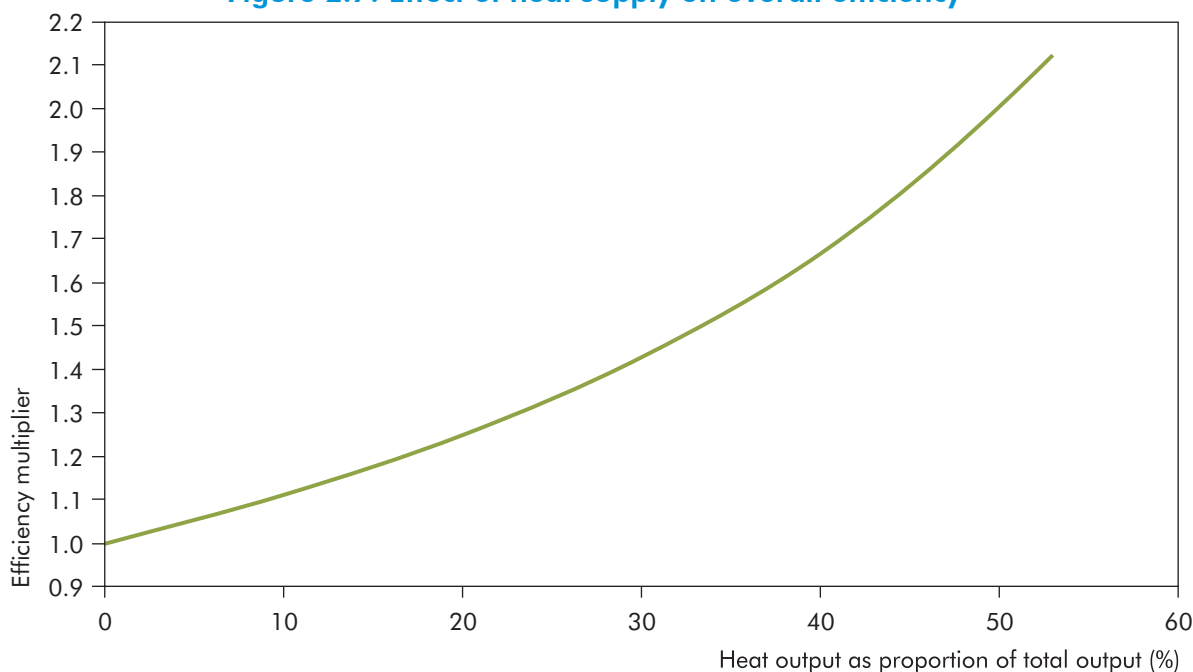

Note: efficiency multiplier = $1 / (1 - x_h)$ where x_h is the heat recovered from rejected or waste heat as a proportion of the total energy output (heat and power).

A more complex relationship and a set of power loss coefficients are described in the German VDI 3986 standard (VDI, 2000). However, this degree of complexity is rarely necessary. The VDI also calls for the heat energy to be expressed in terms of the electrical power which it would have generated had it been used in the main power process. The ASME PTC 46-1996 performance test code, from the United States, permits corrections for exported heat, although these corrections are based on modelling analysis for particular scenarios (ASME, 1997).

In a refinement to the analysis described above, European Union law requires that the heat supply be grossed up to the input energy that would have been needed to supply the same heat from a stand-alone heating boiler operating at 88% efficiency (or 86% in the case of lignite-fired plants).⁸ The power generation efficiency in the above example then becomes:

$$\text{power generation efficiency} = \frac{200}{500 - 150 / 0.88} = 60.7\%$$

⁸ Directive 2004/8/EC of the European Parliament and of the Council of 11 February 2004 on the promotion of cogeneration based on a useful heat demand in the internal energy market and amending Directive 92/42/EEC was published in the *Official Journal of the European Union*, OJ L 52 on 21 February 2004 (pp. 50-60). Harmonised efficiency reference values for the separate production of electricity and heat were tabulated in Commission Decision 2007/74/EC (OJ L 32, 6 February 2007, pp. 183-188), with further detailed guidance in Commission Decision 2008/952/EC (OJ L 338, 17 December 2008, pp. 55-61).

2.4 Efficiency performance assessment periods

Most generation assets, whether operated for power, heat or both, have varying capacity, load or utilisation factors. Their outputs may change depending on the time of day, season, state of the energy market or demand profiles. These changes affect performance since plants must operate under off-design conditions (*e.g.* transients or part-load) or face energy penalties associated with, for example, unit start-ups and shutdowns. Attempting to represent a given plant with a single performance figure is therefore almost meaningless when taken out of temporal context, even before the detail of the calculation is considered. Unfortunately, this is not often recognised in comparisons of technologies, and misleading conclusions can easily be drawn.

Potential bases upon which performance could reasonably be stated include:

- theoretical maximum (based on boundary conditions);
- as-designed (intended full load);
- as-commissioned (formal acceptance test at actual load);
- best-achieved (formal performance assessment test at actual load);
- latest or best-recent (formal performance assessment test at actual load);
- average-daily (by performance monitoring, actual load);
- average-weekly (by performance monitoring, actual load);
- average-monthly (by performance monitoring, actual load);
- average-annual (by performance monitoring, actual load);
- average inter-overhaul (by performance monitoring, actual load); and
- average cumulative-to-date (by performance monitoring, actual load).

As can be seen, the conditions of test may or may not be at the maximum rated output; and may or may not be carried out at, or corrected to, a set of standard reference conditions, including ambient temperature and pressure, and cooling-water temperature. Although tests at the rated output demonstrate the potential performance of the plant, the actual average performance may be significantly lower for the reasons discussed above.

The assessment of overall plant performance needs to establish not just what the plant was designed to, or might achieve, but what it actually does achieve under real operating conditions. It is this measure which ultimately determines the energy use of the plant and its related CO₂ emissions. Although reference to a standard set of conditions might sometimes assist in the technical comparison of plants, it would generally be preferable to use the actual conditions for comparison rather than an arbitrary set of reference conditions.

Most power plants operating within a regulated environment will be required to submit annual reports and data returns from which the main information for whole plant performance assessment should be available. The advantage of adopting an annual operating period is that, irrespective of start and end dates, it will tend to smooth out many of the potentially variable factors such as ambient conditions, seasonal variations, operating regime, short-term plant problems and fuel quality to provide more confidence in the assessment. Assessments based on short-term tests will generally be over-optimistic and exclude many factors which degrade performance during normal commercial operation.

The accuracy of annual performance figures is generally good provided that they are generated within a reasonably well controlled regime. For example, fuel deliveries should be made over calibrated weighbridges and subject to CV and analysis checks, power and heat exports and imports should be measured with calibrated metering devices, and on-site stock adjustments should be taken into account. The overall accuracy of performance calculations should then be within $\pm 2\%$ of the actual energy consumption (or better than $\pm 1\%$ if calibrated belt weighers are used) for a well-managed plant, or within $\pm 5\%$ for a poorly managed installation.

The problem with annual reporting is that it does not necessarily reflect the best potential performance which is possible from the plant under favourable conditions. For this reason, it is suggested that for reference, and where available, the annual performance figure is supplemented by an additional assessment based on short-term formal test data at close to rated output conditions, which should represent the best achieved performance of the unit under the prevailing test conditions. Although such tests could be done in accordance with PTC 46-1996 (ASME, 1997), it is more likely that the boiler and turbo-alternator would be tested separately and the figures combined with suitable corrections for other losses. PTC 4-1998 for boilers specifies an expected accuracy of $\pm 3\%$ of heat consumption (ASME, 1998). However, this must then be combined with uncertainties in the turbo-generator and site losses, so the accuracy of short-term test data is probably no better than for the longer-term assessments.

2.5 Efficiency standards and monitoring

Fired boiler performance standards

There are a number of standards for the performance assessment of coal-fired power plant boilers including:

- BS 2885:1974 (withdrawn British standard);
- DIN 1942 (German standard);
- EN 12952-15:2003 (European standard, similar to DIN 1942).
- PTC 4-1998 (current US standard); and
- PTC 4.1-1964 (1991) (former US standard, superseded by PTC 4-1998).

There are a number of major drawbacks related to the use of these standards.

- The standards are inconsistent and therefore results based on one standard cannot be compared directly with those based on another standard without considerable care.
- They permit a wide range of system boundaries, exceptions and amendments to be made by agreement between parties to the test. This means that, even though two tests may have been undertaken in compliance with the same standard on the same plant, the results may not be comparable. Furthermore, tests on different plants are unlikely to be directly comparable. Clarification of the detailed basis on which a test result has been calculated requires more information than would be reasonable for the purposes of generating overview comparisons of plant performance.
- These test codes focus on the assessment of the boiler which, although very important, is only one component of a coal-fired power plant. While the boiler energy conversion efficiency is an important consideration, the turbo-generator and balance-of-plant equipment have a major bearing on the overall plant performance.
- It would be impractical to apply these standards during normal plant operation because they specify certain test conditions. Similarly, the efficiency obtained under test conditions will not be representative of normal operation.

The main purpose of boiler performance test codes is to provide a contractually binding means of assessing the performance of new, modified or refurbished plant on handover. As such, the standards are a means to an end and act as a convenient and widely accepted measure which can be used with minimal modification for establishing a plant performance benchmark, even if this is not representative of future plant performance. For the reasons outlined above, boiler performance standards are not suitable for the comparison of overall power plant performance.

Whole power plant performance standards

In addition to the differences between boiler standards, there are also differences in the testing standards for steam turbine heat rate, such as ASTM and DIN standards, which could be as high as 2% (approximately 0.8 percentage points in unit efficiency). Problems also arise where plants include unusual design features that are not easily accommodated within standard test methods. This raises the question of whether the determination of whole plant efficiency is a more direct and appropriate method of providing efficiency data. The use of a whole plant method might also make the technology used within the plant largely irrelevant to the overall efficiency determination, reducing uncertainty and the potential for discrepancies.

Two whole-plant performance standards were considered in this study. The first, and one which is widely used for new gas-fired plant, is the US ASME PTC 46-1996 *Performance Test Code on Overall Plant Performance*.⁹ The second is the German VDI 3986 for the *Determination of Efficiencies of Conventional Power Stations*. The latter standard is somewhat less detailed than the ASME test code and, although relevant to this study, is not widely used outside Germany. However, they are both written around the requirement to provide a framework for short-term tests to verify that contract requirements have been met. Both standards contain clauses that mean their use cannot be relied upon to be consistent. The standards can still be deemed to have been applied, provided that the methods, boundary conditions and values used are agreed between the parties to the tests. This does not therefore guarantee a common basis for assessment, although the use of a standard of this type does provide some consistency.

In general, most large power plant contracts include efficiency specifications and guarantees based on the major plant components which are then combined by a method determined in the contract to produce an overall plant efficiency value. These whole plant efficiency values are not generally in accordance with any formal standard, although the efficiencies of sub-systems and components usually are.

Many new-build contracts use equations of the form shown below to calculate whole plant efficiency.

$$\text{net electrical power output} = P_g - P_a$$

Where P_g is the gross generated power and P_a is the auxiliary power consumption. The overall power station efficiency (η_o) and heat rate is defined as follows:

$$\eta_o = \eta_B \times \eta_{TG} \times \eta_T$$

$$\text{heat rate} = 3\,600 / \eta_o \text{ (kJ/kWh)}$$

Where η_B is the boiler thermal efficiency, η_{TG} is the turbo-generator thermal efficiency and η_T is the transformer efficiency.

This form of component efficiency combination is acceptable only where it has been verified that all the power and energy flows have been taken into account. Although the combination of plant sub-component efficiencies appears simple, the overall efficiency depends on sub-component values which are generally derived from complex calculations based on extensive data obtained with test-grade instrumentation under carefully controlled conditions. As such, these forms of efficiency determinations are rarely performed and are unsuitable indicators of normal running performance of any plant.

PTC 46-1996 – Performance test code on overall plant performance

This code is applicable to a number of plant types and fuels. However, it is not often applied in new plant contracts, either because it is not recognised or because there are commercial reasons to implement plant performance requirements and assessments by sub-component (e.g. boiler, turbine, heat recovery steam generator (HRSG), gas turbine, cooling system). PTC 46-1996 requires that the heat input to the plant is measured via fuel mass flow and heating value, or via heat flow and efficiency of the boiler, which must then be determined in accordance with PTC 4-1998. PTC 46-1996 is most commonly used in relation to gas-fired combined cycle plant.

⁹ In addition, ASME PTC PM-2010 *Performance Monitoring Guidelines for Power Plants* replaces a 1993 edition.

VDI 3986 – Determination of efficiencies of conventional power stations

This standard, issued in 2000, is somewhat less extensive than PTC 46-1996 and although relevant to this study is not widely used outside of Germany. It offers a framework for short-term tests to verify that contract requirements have been met, and provides for a number of plant arrangements. The standard permits the expression of efficiency on different bases and allows deviation from the test methods by agreement of the parties. As with PTC 46-1996, there is some discussion included on the measurement methods and the associated uncertainties, as well as the required measurement equipment accuracies.

Other performance standards

Although PTC 46-1996 is the only commonly applied standard for whole plant performance assessment, there are other standards in place that set performance criteria for new plant. One example is the Australian Greenhouse Office *Generator Efficiency Standards* (GES). These set targets for the minimum acceptable level of performance for new power plants, depending on size and type, as a means of benchmarking. The GES is described in more detail in Appendix III.

It is generally assumed that fuel for mobile plant, on-site transport, utility vehicles and fuel handling vehicles is not included in power plant performance analysis since the energy and related CO₂ emissions from these activities are negligible in comparison to the main power and heat generation activities of a power plant.

Performance monitoring

In the United Kingdom in the early 1970s, the Central Electricity Generating Board (CEGB) developed a common means of power plant performance monitoring, known as the Station Thermal Efficiency Performance (STEP) system. This system was devised by a national working party to calculate fuel consumption and monitor the performance of plants against “achievable” performance. By necessity, the system included many assumptions related to target performance and this created a degree of uncertainty associated with the calculation of allowable deviations from these targets. Parts of the assessment, including “cost-of-losses” calculations, were integrated into routine operations and later into computer-based monitoring systems.

Similar schemes have been developed elsewhere, and the rise of commercial efficiency monitoring systems has been observed over the last two decades. However, most commercially available software systems for efficiency or heat-rate monitoring have drawbacks; they depend on certain assumptions, and some rely on reliable and accurate instrumentation, such that they are only useful for monitoring performance trends rather than efficiency determination.

Many systems rely on estimating the turbo-alternator heat consumption, and therefore the fuel consumption, via a correction for estimated boiler efficiency, all based on averaged plant operating parameters and an extensive set of reference data for the plant in question. It would not be feasible to implement a system of this complexity for assessing the comparative performance of many different plants around the world or their relative potentials for improvement.

2.6 Reporting bases for whole plant efficiency

In most regions of the world, efficiency is expressed on the basis of the fuel’s gross calorific value (GCV) and net electrical power output.¹⁰ This appears reasonable for the purposes of comparison since it reflects the total energy input and useful electricity output. However, other bases are also used. In Europe, for example, it is common to express efficiency on a net calorific value (NCV) and net power output basis, reflecting the difficulty of recovering latent heat and coal trade on a net calorific value basis.¹¹

¹⁰ See footnote 4.

¹¹ Condensing boilers exist, but the selection of materials to avoid acid-gas corrosion adds to their capital cost.

Where there are multiple units on a power station site, the “station” consumption for common services is generally not included in the efficiency determination of individual units; even for unit-based calculations, the plant boundaries, test standards and efficiency calculations can vary significantly. In most cases, unless otherwise stated, efficiencies are quoted for convenience on the basis of design, acceptance or expected maximum output efficiencies, and are generally not representative of those achieved in practice.

2.7 CO₂ emissions reporting

This section explores the growing requirement to accurately measure and report CO₂ emissions from fossil fuel use. The three-part ISO 14064 standard covers CO₂ emissions reporting and verification (ISO, 2006).

EU Emissions Trading Scheme

The EU Emissions Trading Scheme (ETS) is the largest greenhouse-gas emissions trading scheme of its kind in the world.¹² At present, the scheme requires the annual reporting of CO₂ emissions by mass, similar to routine measurement and reporting undertaken in countries such as the United States. Specific emissions reporting per unit of production (*e.g.* gCO₂/kWh) is not required. Emission calculations are based on fuel used and agreed oxidation factors. Reporting of figures on the basis of actual oxidation factors, rather than the assumed values, is permitted where actual values are available and can be verified.

Participating countries have a national allocation, agreed by the European Commission (EC), which is allocated or auctioned to major emitters by governments. Emitters must either comply with their allocated CO₂ cap using the allowances they hold, buy additional allowances to cover their requirements, or pay a severe fine for exceeding their allocation (and buy the missing allowances). Allowances are freely traded and surplus allowances can be sold. Since trading began in 2005, market prices have varied considerably. Following an amendment to the ETS Directive, agreed on 17 December 2008, a greater share of allowances must be auctioned from 2013, with full auctioning generally required in the electricity sector.¹³

The scheme does not provide a direct means of comparing CO₂ emission rates of different technologies, although the preparation of the statistics makes this possible in detail at source and by aggregation of sectors at national level.

Article 14 of the ETS Directive requires the European Commission to elaborate guidelines for monitoring and reporting greenhouse-gas emissions under the ETS; monitoring and reporting guidelines were adopted on 29 January 2004 with Commission Decision 2004/156/EC.¹⁴ Article 14 also requires Member States to ensure that emissions are monitored in accordance with these legally binding guidelines. Since 2004, the guidelines have been subject to a number of revisions (Commission Decisions 2007/589/EC, 2009/73/EC, 2009/339/EC and a draft amendment covering CCS).

Greenhouse gases and life-cycle assessment

This report focuses on energy efficiency and CO₂ emissions at coal-fired power plants during fuel conversion into useful output energy. The purpose of clarifying whole plant efficiency and emissions reporting methodologies is to provide a relatively simple, common basis for relative performance assessment.

12 Directive 2003/87/EC of the European Parliament and of the Council of 13 October 2003 establishing a scheme for greenhouse-gas emission allowance trading within the Community and amending Council Directive 96/61/EC was published in the *Official Journal of the European Union*, OJ L 275 on 25 October 2003 (pp. 32-46). For a general description of the EU Emissions Trading Scheme, see <http://ec.europa.eu/environment/climat/emission.htm>.

13 *Official Journal of the European Union*, OJ L 140, 5 June 2009, pp. 63-87.

14 *Official Journal of the European Union*, OJ L 59, 26 February 2004, pp. 1-74.

Emissions of methane, CO₂ and other greenhouse gases associated with the extraction, preparation and delivery of fuel to power plants are not considered. Similarly, the greenhouse-gas emissions associated with the construction of coal-using plants are not taken into account in this operational assessment, although they might be considered as part of a more detailed life-cycle analysis, for example as part an environmental impact assessment for a new plant.

There are a number of published studies on methane production from mining and the carbon cost of transporting bulk commodities from which generic relationships could be created to estimate the GHG emissions footprint of coals sourced from different mines and transported over different distances using different modes of transport (*e.g.* Defra, 2008; Mills, 2005; and EPA, 2010).

CO₂ reporting issues

Carbon or CO₂

Most reporting systems in use around the world report on the basis of CO₂ emissions and use factors to report other greenhouse-gas emissions as their CO₂ equivalent (CO₂e). Occasionally, CO₂ emissions are quoted in terms of carbon (C), or confusingly are stated as “carbon” when they are in fact CO₂. The equivalence in mass terms between carbon dioxide and carbon is simply the ratio of their molecular masses CO₂:C, this being 3.6632 (IUPAC, 2005).

Input versus output basis

Input-based emission calculations and limits for the mass of CO₂ emitted per unit of input energy, expressed in units such as tCO₂/GJ or lb/MMBtu coal, create a poor comparison of specific emission rates. They imply that producing the same total emissions from the same quantity of fuel represents equivalent performance. In reality, although a more efficient plant consuming the same mass of fuel as a less efficient plant creates the same total quantity of CO₂, it does so with the benefit of producing more useful output energy. Emission standards based on useful energy output (*e.g.* tCO₂/GWh) are therefore important, since they recognise the benefits of higher efficiency and incentivise the development and implementation of cleaner, more efficient technologies.

Mass versus volume basis

Reporting gaseous emissions on a volume basis is not straightforward. Quantities must be expressed against a reference temperature, pressure, moisture and oxygen concentration if they are to be correctly compared or assessed against emission standards. In contrast, reporting emissions on a mass basis is absolute and avoids any requirement for volumetric corrections. CO₂ emissions in mass units, rather than volume units, are therefore preferred and are widely used by most reporting systems and analysts.

Units of output

To report specific CO₂ emissions in terms of a power plant’s useful output requires heat and electrical energy to be combined, as for the overall efficiency calculations described above. Common energy units are needed, *e.g.* gigajoules (GJ) or megawatt hours (MWh), with simple conversion factors between these.

Typically, large subcritical coal-fired utility plants today produce around 900 kgCO₂/MWh. This figure becomes higher for high-moisture fuels, or for plants operated at low load factor or of inferior design. This can be compared to around 740 kgCO₂/MWh for state-of-the-art modern supercritical plants, and potentially around 600 kgCO₂/MWh for plants with advanced steam conditions that are currently under development.

Carbon dioxide capture and storage (CCS) offers perhaps the only way to make further reductions in CO₂ emissions from conventional coal-fired plants. CCS would cut emissions to 60-70 kgCO₂/MWh, assuming >90% CO₂ capture from future state-of-the-art plants. Potentially, a net emission of zero is possible where the plant also fires a small proportion (approximately 10-15% by heat input) of biomass material to compensate for the residual CO₂ emissions not captured in the plant.

Figure 2.8: Example of relationship between CO₂ emissions and net plant efficiency (with and without CCS)

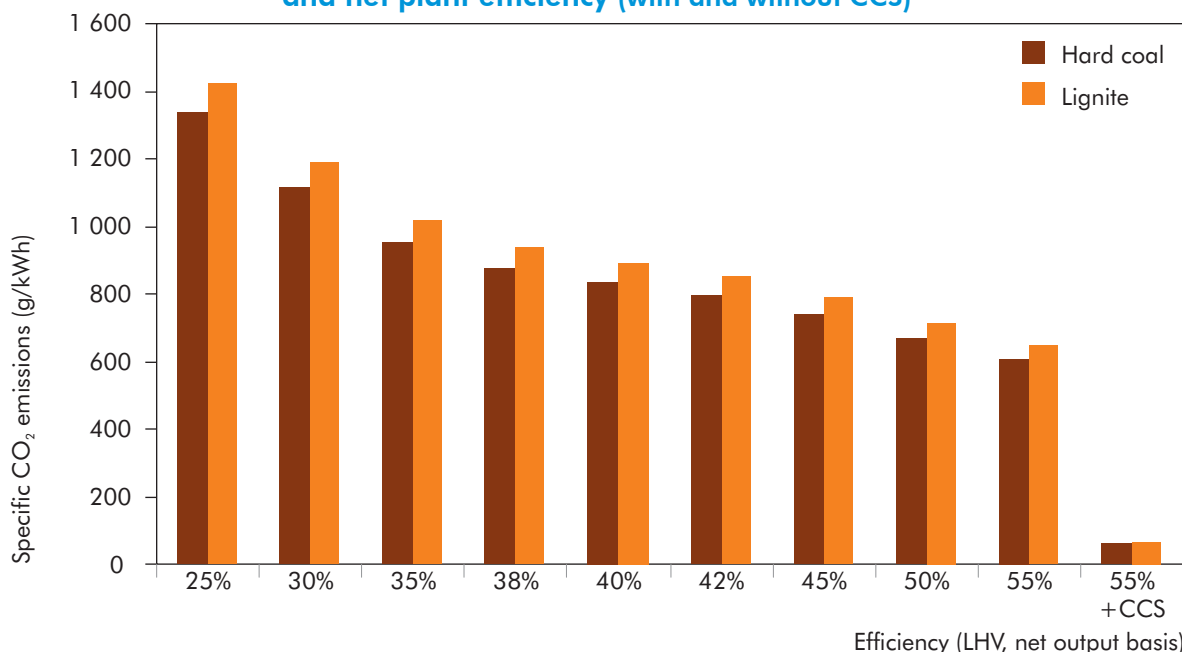

Note: Specific CO₂ emissions are calculated here using IPCC default emission factors for stationary combustion in the energy industries: 94.6 kgCO₂/GJ for bituminous coal used for power generation and 101.0 kgCO₂/GJ for lignite (IPCC, 2006). It is assumed that 98% of the fuel carbon is oxidised, the remaining 2% being retained in ash, although this varies in practice (IPCC, 1996). For the case shown with CCS, a CO₂ capture rate of 90% is assumed.

Source: IEA analysis.

Determination of emitted CO₂

Commercial instrumentation is available for monitoring CO₂ concentration and flue gas volume flows. Given the limitations of such instrumentation, the accuracy of directly measured CO₂ release is probably no better than that derived by indirect calculation. Moreover, many plants do not measure flue gas volume flow and CO₂ concentration, so indirect calculation of emitted CO₂ is the only option and can be applied consistently.

Where FGD processes are employed for SO₂ removal, the mass release (M_{FGD}) of carbon from the reaction between limestone (CaCO₃) and flue gas should be considered in the plant assessment, although its contribution to total emissions will be relatively small. The release mechanism is:

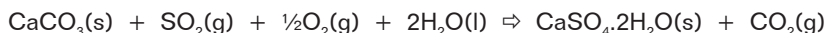

The treatment of CO₂ emissions from plant incorporating carbon capture is more difficult since the removal efficiency of the capture plant needs to be included in the calculation. It is likely that a removal efficiency factor (X_{CCS}) of 90% or more would be achieved. The calculation of CO₂ emissions must account for all these additions and reductions, such that the mass release (M_{out}) is:

$$M_{\text{out}} = 3.6632 \times (M_{\text{in}} + M_{\text{FGD}} - M_{\text{ash}}) \times (1 - X_{\text{CCS}})$$

Where M_{in} is the mass of carbon in the fuel input and M_{ash} is the mass of unburned carbon retained in ash.

The use of further correction factors for CO₂ emissions follows similar principles to those for efficiency calculations. For the purposes of developing a common plant assessment methodology, specific greenhouse-gas emissions analysis is limited only to the CO₂ produced during fuel conversion into useful supplies of energy, including electricity and heat. As with efficiency, proper account must be taken of any heat supplied when calculating specific CO₂ emissions per unit of electricity supplied.

3. GENERIC RECONCILIATION METHODOLOGY

By taking into account the factors presented in Section 2, it is possible to derive a common methodology for expressing and comparing whole plant efficiency and specific CO₂ emissions relative to useful energy output for a wide range of different conversion plant types and fuels. For convenience and consistency, it is recommended that units of measurement are in accordance with the ISO 80000-1:2009 standard system (ISO, 2009). An example calculation, illustrating the methodology’s application, is included at Appendix II.

3.1 Process boundaries

To avoid the need for performance details of individual plant components, a system boundary should cover the entire power plant, from fuel reception to the interface with the power or heat transmission system. This may or may not coincide with a clear physical boundary, depending on the plant layout and its application.

Figure 3.1: Example of a process boundary showing energy in-flows and out-flows for a power plant

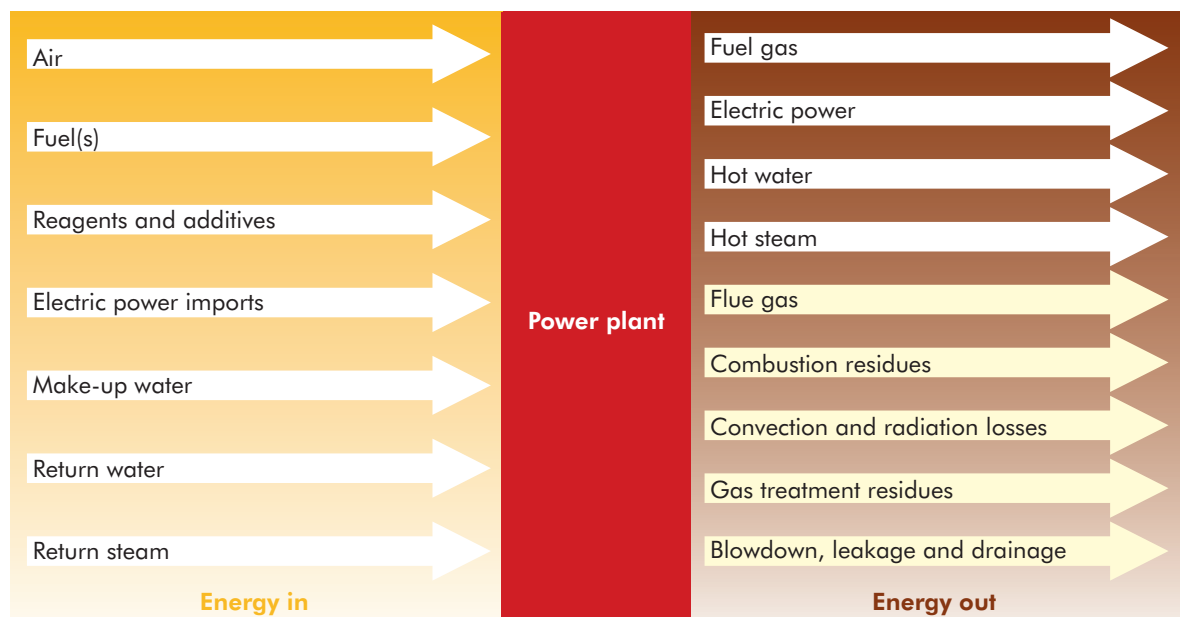

Source: E.ON UK plc.

This approach simplifies the assessment of overall plant performance and can be applied consistently to many plant types and fuels. It also removes any debate regarding how internal energy flows, such as works power or own-use consumption, or water and steam interconnections, should be accounted for.

Such a “black-box” approach to the whole power plant island is shown in Figure 3.1, in which the energy output associated with the shaded flows can be ignored in the calculation of overall plant efficiency. Although in the short term, the measurement of some of these parameters may be subject to measurement error, the accuracy of data over longer time periods, and particularly annual periods, should be high.

A similar approach is taken in both VDI 3986 and PTC 46-1996, as shown in Figures 3.2 and 3.3.

Figure 3.2: System boundary for water-steam process

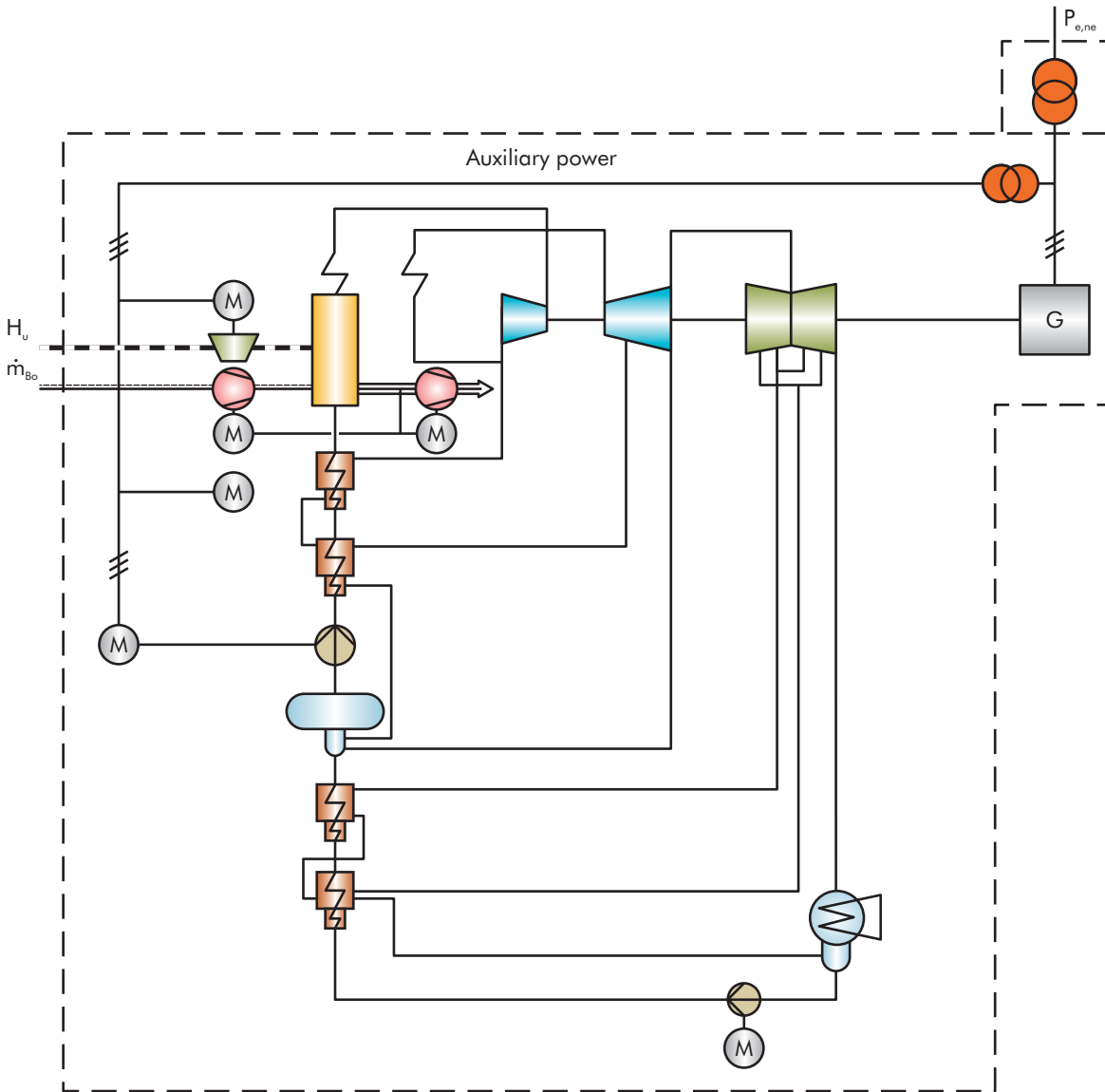

Source: VDI (2000). Reprinted by permission of the publisher. © VDI, 2000.

Figure 3.3: Steam turbine plant test boundary

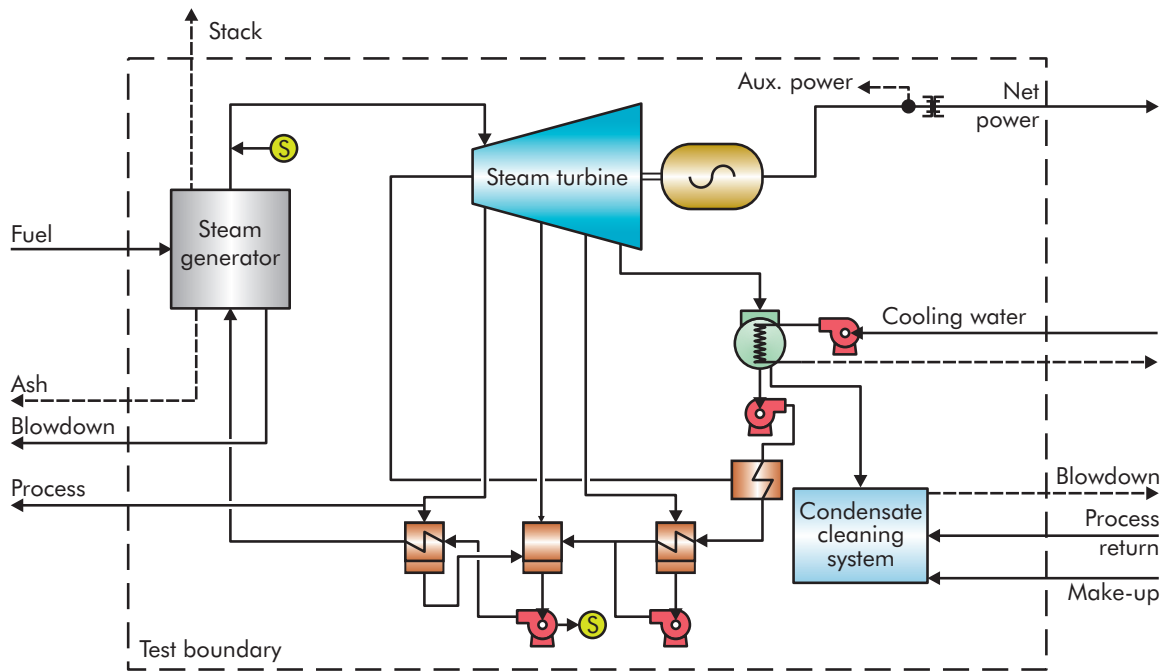

Source: ASME (1997). Reprinted from ASME PTC 46-1996, by permission of The American Society of Mechanical Engineers. All rights reserved.

Similarly, Figure 3.4 is taken from the Australian GES and again illustrates the approach of using a whole-plant boundary, even where the plant cogenerates heat and power.

Figure 3.4: Australian GES plant boundary with co-generation

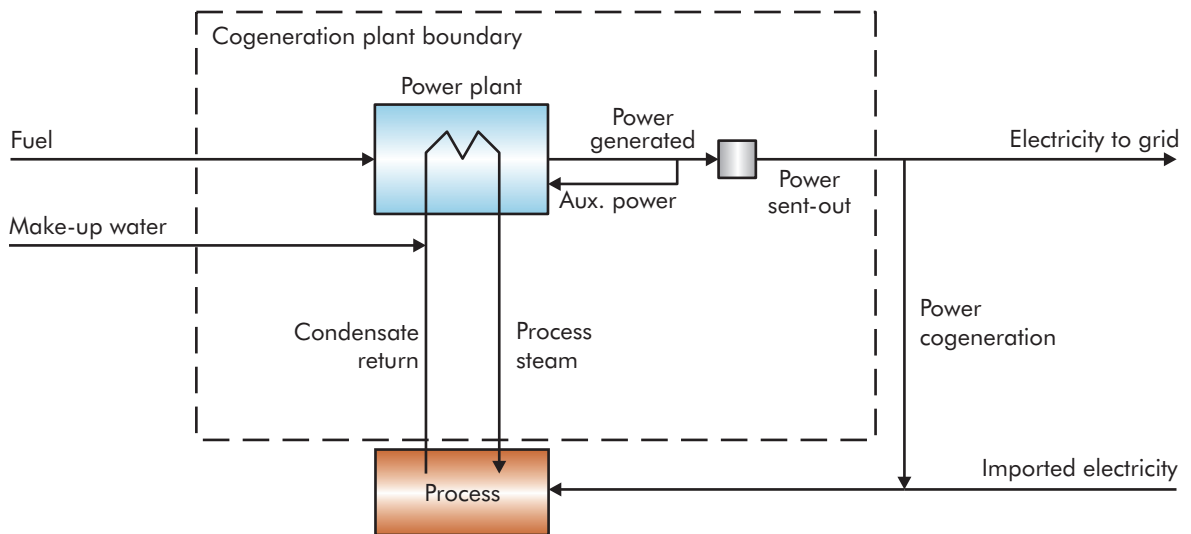

Source: AGO (2006). Reprinted by permission of the publisher. © Department of Climate Change and Energy Efficiency, 2006.

3.2 Input data requirements

In order to perform an assessment of power plant performance, plant operators must ensure that they:

- weigh, or obtain weights for, all delivered fuel using calibrated equipment;
- undertake representative sampling and analysis of all fuel supplies to determine the average values of calorific value, moisture content, ash and sulphur;
- meter power import and export using calibrated equipment in order to determine net power export; and
- where applicable, meter and determine the heat content of incoming and outgoing water and steam in order to determine net heat export.

The average annual values of these parameters may then be used to determine plant performance indicators. Where there is more than one unit, such information must be provided on an overall station basis as a minimum, but the provision of supplementary information for individual units could also be required. The minimum annual data requirements for each site are shown in Table 3.1. Some basic data for each plant, discussed in more detail in Section 3.3, would also ideally be provided.

Table 3.1: Annual plant operating data requirements (to be completed by operator)

Data item	Quantity	Unit
Total fuel heat used (gross)		PJ
Total fuel mass consumed		t
Net electrical power export		TWh
Net water and steam energy export (where applicable)		PJ

Since light-up and stabilisation fuel is used at all coal-fired plants, they may all be considered as multi-fuel installations. This is also the case where opportunity fuels are used, such as residues and by-products from other processes or biomass energy crops. This creates some difficulty, but it should be possible to express the overall mix of fuels consumed on a bulk average mass and average CV basis.

In practice, it would be beneficial to include more detailed data to enable normalisation and better understanding, as shown in Table 3.2. It is also considered important that a brief commentary be provided to enable the context of the data to be better understood. This might, for example, provide clarification on poor reported efficiencies or note planned improvements.

Table 3.2: Supplementary data requirements (to be completed by operator)

Data item	Quantity	Unit
Average running load as % of maximum continuous rating (MCR)		%
Average cooling-water inlet temperature		°C
Average ambient temperature		°C
SO ₂ removal efficiency		%
Plant mode of operation		
Fuel 1 Type		
Contribution to total gross heat		%
Higher heating value		GJ/t
Average fuel moisture		%ar
Average fuel ash content		%ar
Average fuel volatiles content		%ar
Average fuel sulphur content		%ar
Fuel n Type		
Contribution to total gross heat		%
Higher heating value		GJ/t
Average fuel moisture		%ar
Average fuel ash content		%ar
Average fuel volatiles content		%ar
Average fuel sulphur content		%ar
Supporting comments:		

3.3 Output data

The assessment of the annual performance of a given power plant should be held in a database to facilitate comparison with other data. The final evaluation of plant performance in accordance with the methods described here needs to be captured in a clear and concise format, and must concentrate on the key indicators which are relevant to the creation of the database. Part of the record for each plant needs therefore to comprise the summary output data and part needs to comprise summary descriptive data. The summary data derived from the proposed calculations might include those shown in the first two columns of Table 3.3. These could be normalised and compared with best practice performance under reference conditions through a set of corrections, as shown in Table 3.3, to judge the potential for improvement.

Table 3.3: Template for overall power plant assessment summary

	As-run	Normalised as-run	Best practice	Normalised best practice	Relative performance, %
Carbon dioxide emissions					
†CO ₂ /GJ total energy output					
†CO ₂ /MWh net electrical output					
†CO ₂ /GJ net heat output					
MtCO ₂ /year					
Overall plant efficiency					
% GCV basis					
% NCV basis					
Power generation efficiency					
% GCV basis					
% NCV basis					

Whether comparisons should be made on an “as-run” basis or a “normalised” basis is debatable. Ideally, they should be based on “as-run” figures. However, where constraints on the adoption of best practice exist, it might be more reasonable to make comparisons on a normalised basis. Normalisation of “as-run” values for comparison with “normalised best practice” values should only take into account those external factors considered to be uncontrollable constraints, but exclude controllable design parameters, as illustrated by the examples in Table 3.4.

Table 3.4: Examples of uncontrollable external constraints and controllable design parameters

Uncontrollable constraints	Controllable constraints
Type of cooling-water system employed	Steam conditions
Ambient temperature	Plant age
Mode of plant use	Unit size
Average running load	Boiler feed-water temperature
	Reheat pressure drop
	Spray cooling requirement
	Auxiliary power consumption

The “best-practice” level of performance used in the comparisons should be based on a reference data set for a specified plant of the appropriate technology type, firing a mid-range fuel composition. This best-practice reference performance can then be corrected for the actual fuel being used in order to obtain a “normalised best practice”. The normalised best-practice correction should be based on composite fuel types and properties, covering lignite, sub-bituminous coal, bituminous coal and anthracite, sometimes co-fired with other fuels. Separate master reference data sets would be required to cover technologies such as pulverised coal combustion, bubbling fluidised bed combustion, circulating fluidised bed combustion, pressurised fluidised bed combustion, integrated gasification combined cycle and others. The IEA has recently identified and described examples of best-practice plants by technology type (IEA, 2007).

The reference best-practice performance should also be corrected for any combined heat and power production.

The reference best-practice performance should be based on a reasonable expectation of this being achieved on an annual basis, and therefore should not reflect design performance or performance during commissioning tests. Figure 3.5 illustrates this graphically. Allowances should be made for:

- deterioration appropriate to a plant three years into its maintenance cycle;
- reasonable levels of “controllable” losses;
- 80% operational load factor;
- requirement for and impact of frequency response control on performance;
- average ambient conditions of 15 °C, 101.3 kPa and 60% RH;¹⁵
- inland station location with a closed-circuit cooling-water system;
- plant equipped with low-NOx burners, over-fire air, selective catalytic reduction, wet FGD scrubbers and electrostatic precipitators; and
- whole plant efficiency assessment based on 2 × 600 MW units.

Figure 3.5: Comparing plant performance with best practice

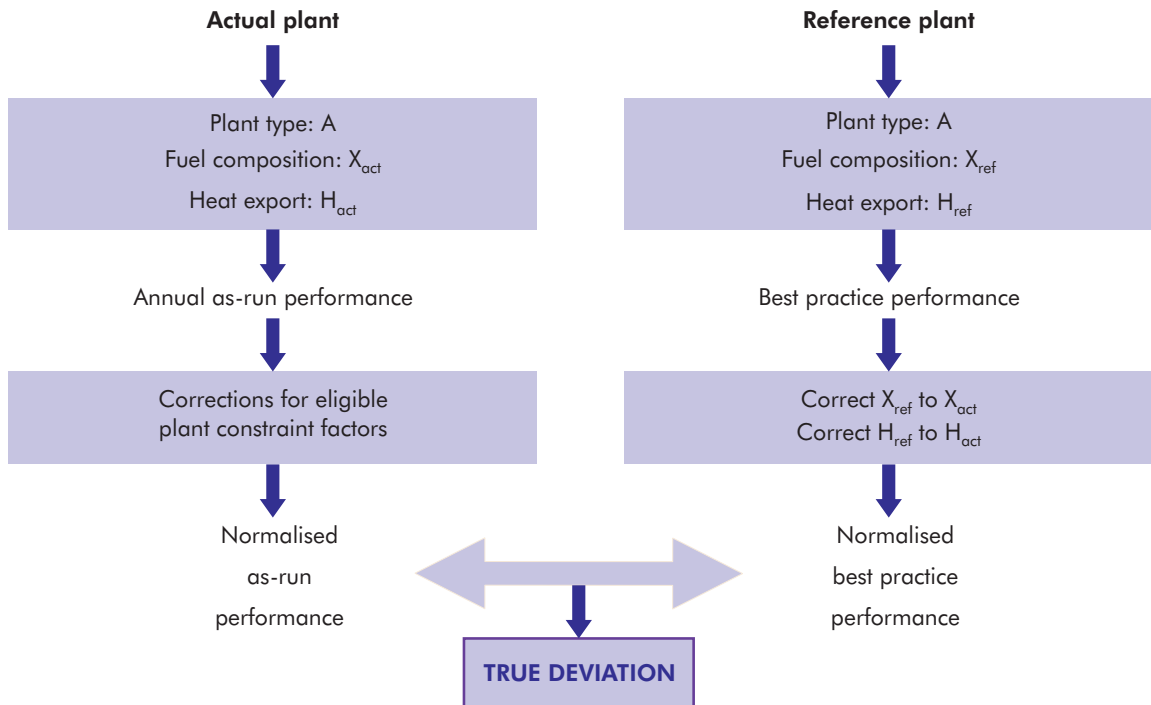

The submission of plant data should contain details to assist with an understanding of the constraint factors, and might include information listed in Table 3.5. Unit information is required, even where the whole plant performance is expressed on an aggregate basis, since power plants often comprise units of different capacities, ages and design. However, it would be more difficult and more prone to error if analyses were carried out on a unit-by-unit basis. For this reason, analysis should be on a power plant basis, rather than an individual unit basis.

The information shown in Table 3.5 is known by plant operators and can be easily supplied for input into a database. Much of the information will not change from one reporting period to the next; annual data updates will relate to the calculation of overall plant efficiency and CO₂ emissions.

15 As per ISO 3977.

Table 3.5: General plant information (to be completed by operator)

General plant information		
Plant name		
Country		
Location		
Plant owner		
Plant operator		
Number of units		
Unit 1		
Commissioning year		
Technology type		
Design fuel type		
Unit rated power generation capacity		MW (gross)
Unit maximum heat supply capacity		MWth
Best measured unit overall energy efficiency (GCV, net sent-out basis)		%
Best measured unit electrical efficiency (GCV, net sent-out basis)		%
Design fuel GCV		GJ/t
Design fuel moisture content		%ar
Design fuel ash content		%ar
Design fuel sulphur content		%ar
Cooling-water system type		
Design main steam temperature		°C
Design main steam pressure		bar
Number of reheat stages		
Reheat temperature		°C
Flue gas desulphurisation		
Selective catalytic reduction		
Low-NO _x burners/over-fire air		
Electrostatic precipitators/fabric filtration		
Air separation unit		
CO ₂ capture		
Unit n		
...		

It should be noted that the IEA Clean Coal Centre already maintains an extensive coal-fired power plant database which has been used recently in evaluations of plant efficiency.¹⁶ It may be possible to use this as the basis for an expanded database which would satisfy the requirements for a global coal-fired plant efficiency and emissions reporting system. Data could be reported at a number of different levels, for example for each unit, plant, plant type, operator or country.

¹⁶ The CoalPower5 database can be accessed at www.iea-coal.org.uk/site/ieacoal/databases/overview.

Access to, and use of such data would need to be addressed at the development stage of a new reporting system. Clearly, the data would be of use at global and national levels, without any requirement to be specific about individual power plants or operators. However, there may be pressure to make plant information publicly accessible which points to the need for formal agreements and controls on what is likely to include commercially sensitive data. In reality, there is little information described here which could not be obtained from material in the public domain, or estimated by making reasonable assumptions. The proposal here is that data would be available for each power plant.

The implementation of a generic assessment calculation needs to be performed in a manner which is consistent and straightforward, but flexible enough to suit multiple requirements without extensive modifications. This implies that assessments should use standard database software, where the calculations are transparent and revisions to data analysis can be made easily.

3.4 Generic corrections

Fuel quality

Fuel quality is characterised in terms of its heating value, which is generally quoted as a gross calorific value (GCV) or higher heating value, together with its moisture, ash and volatile material content (the proximate analysis) and usually, for reasons of environmental control and protection, its sulphur content.¹⁷ The fuel's ultimate analysis, including carbon, hydrogen, oxygen and nitrogen, is not analysed routinely. Any wide-scale data collection and analysis needs to be based on readily available information for the fuels used.

Boiler test methods, used for contractual purposes, often include corrections to performance test results that account for any differences between the fuel used for tests and that specified in the contract for performance guarantees. These corrections can vary in form, but often adjust loss factors, particularly carbon-in-ash and excess-air or dry-gas losses. Such corrections are not necessarily useful for the more general analysis of fuel quality impacts on whole plant operational efficiency. A number of computer-based expert systems exist for fuel quality impact assessment; complex algorithms assess the overall impact on plant, including on works power consumption and by-product sales, such as gypsum. These systems are again not well suited to generic corrections since they assess performance changes for a given plant with different fuels, rather than the performance variations between different plants.

The main fuel characteristics affecting plant efficiency and specific CO₂ emissions are moisture content and the carbon-to-hydrogen ratio of the fuel's combustible component. Fuels with the same calorific values, but different carbon-to-hydrogen ratios, will produce different amounts of CO₂ per unit of heat released. A fuel which contains more moisture will generally have a lower calorific value and a larger difference between its GCV and NCV. In practical applications, where the latent and sensible heat in the flue gas is not recovered, increasing moisture content will tend to increase plant losses and fuel use.¹⁸

Figure 3.6, derived from a large data set, shows empirically how fuel calorific value is related to moisture content. Although there is a degree of scatter for fuels with moisture contents around the 5%-10% range, there is a general reduction in GCV for fuels with higher moisture contents. Figure 3.7, from the same data set, shows the ratio of gross to net calorific values plotted against "as-received" moisture content.

¹⁷ See footnote 4.

¹⁸ See footnote 5.

Figure 3.6: Relationship between coal GCV and as-received moisture content for a large data set

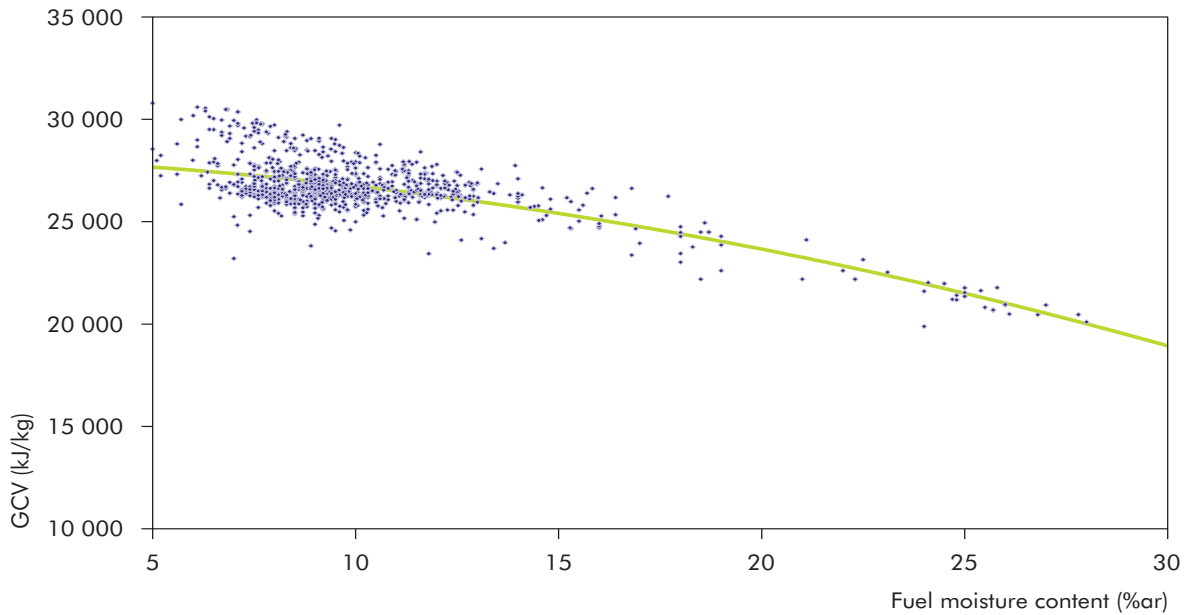

Source: E.ON UK plc.

These data suggest that the difference between gross and net calorific values can be estimated from fuel moisture content. This is useful since, although calorific value and proximate analyses (volatile matter, ash and moisture content) are often determined or known with reasonable accuracy, the more detailed elemental composition, needed for more precise analysis, is often not known.

Figure 3.7: Effect of coal moisture on GCV:NCV ratio for a large data set

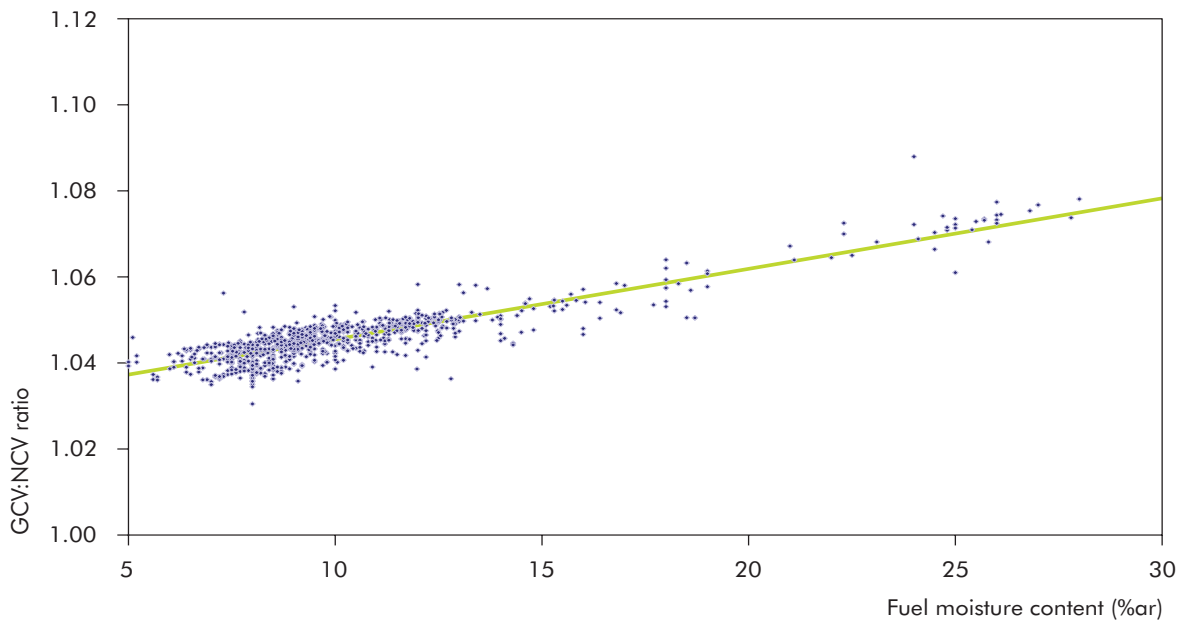

Source: E.ON UK plc.

Typically, it is only the GCV of a fuel which is determined analytically: the NCV or lower heating value is calculated using the equation (White, 1991):

$$\text{NCV} = \text{GCV} - (212.1 \times \text{H}) - (24.4 \times (\text{M} + (0.1 \times \text{A}))) - (0.7 \times \text{O})$$

Where NCV and GCV are expressed in kJ/kg and H (hydrogen), M (moisture), A (ash) and O (oxygen) are % by mass.

If oxygen content is not known, then the following equation may be used for coal (*ibid.*):

$$\text{NCV} = \text{GCV} - (212.1 \times \text{H}) - (24.4 \times (\text{M} + (0.1 \times \text{A}))) - 6$$

The same calculation can also be performed without a figure for ash content, using the equation (*ibid.*):

$$\text{NCV} = \text{GCV} - (91.1436 \times \text{H} + 10.3181 \times \text{M} + 0.3439 \times \text{O})$$

Where H, M and O are on an “as-received” basis. Net calorific value can also be calculated from the proximate analysis of the fuel as follows (*ibid.*):

$$\text{NCV} = \text{GCV} - 13.9V - 7.9A - 30.6M + 6.12$$

Where V (volatile matter content), A (ash content) and M (moisture content) are on an “as-received” basis.

The disadvantage of determining NCV in this way is that fuel-composition data are often limited. Estimates must then be made. By combining the data presented in Figures 3.6 and 3.7, the ratio of gross to net calorific values can be estimated from the GCV of the fuel, as shown in Figure 3.8.

Figure 3.8: Variation of GCV:NCV ratio with GCV for a large data set

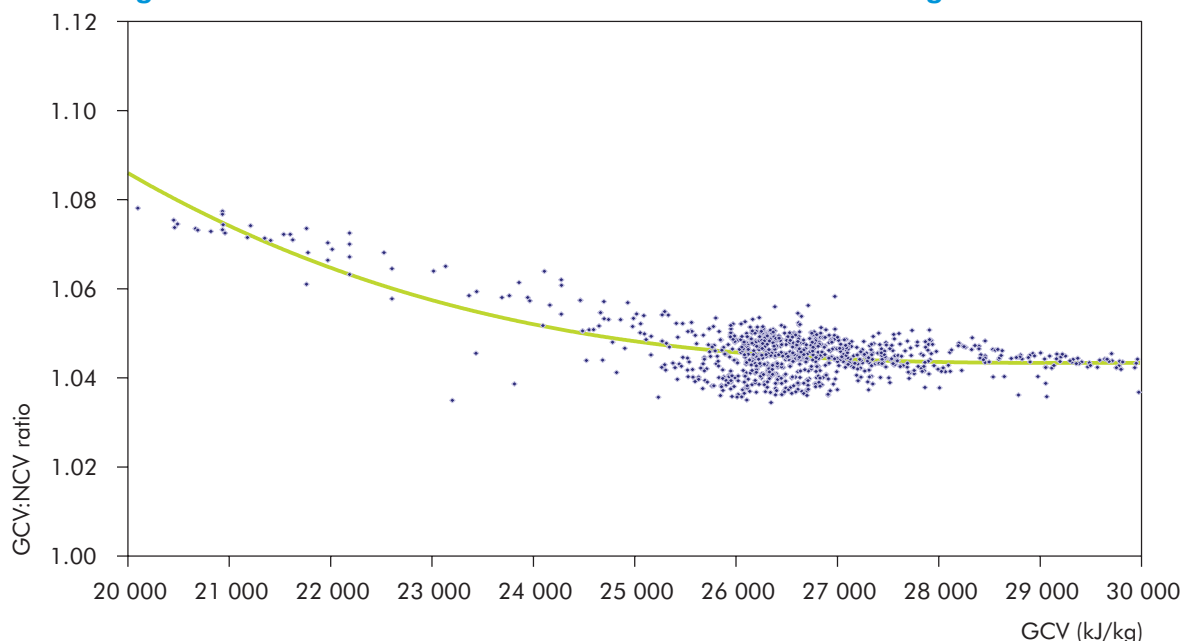

Source: E.ON UK plc.

Comparison with Figure 3.7 suggests that fuel moisture is a better indicator of GCV:NCV ratio, but GCV can provide a reasonable estimate if moisture content is not available.

Table 3.6 shows the typical range of GCV:NCV ratios for a selection of commonly used fuels. In the case of biomass, the moisture content can vary significantly and so two values have been included, one for “wet” biomass with a moisture content of 50% and one for “dry” biomass with a moisture content of 10%.

Table 3.6: Typical GCV:NCV ratios for various fuels

Fuel	Typical GCV:NCV ratio
“Wet” biomass	1.250
Lignite	1.159
Natural gas	1.108
“Dry” biomass	1.091
Sub-bituminous coal	1.074
Heavy fuel oil	1.059
Light fuel oil	1.058
Bituminous coal	1.045
Anthracite	1.025

Source: E.ON UK plc.

The carbon-to-hydrogen ratio of fuels can be determined from the ultimate analysis. However, such analysis are not performed routinely. The following formula, based on work by Seyler-Dulong (White, 1991), enables an estimate of the carbon content of coal from its moisture, ash and volatile content, and GCV. These parameters are generally known from the proximate analysis or can be estimated.

$$\text{carbon \% (ar)} = ((0.0014081 \times \text{GCV}_{\text{daf}}) - (0.21633 \times \text{VM}_{\text{daf}}) + 43.4) \times (100 - M - A) / 100$$

Where GCV_{daf} is expressed in kJ/kg and VM_{daf} , M and A as % by mass.

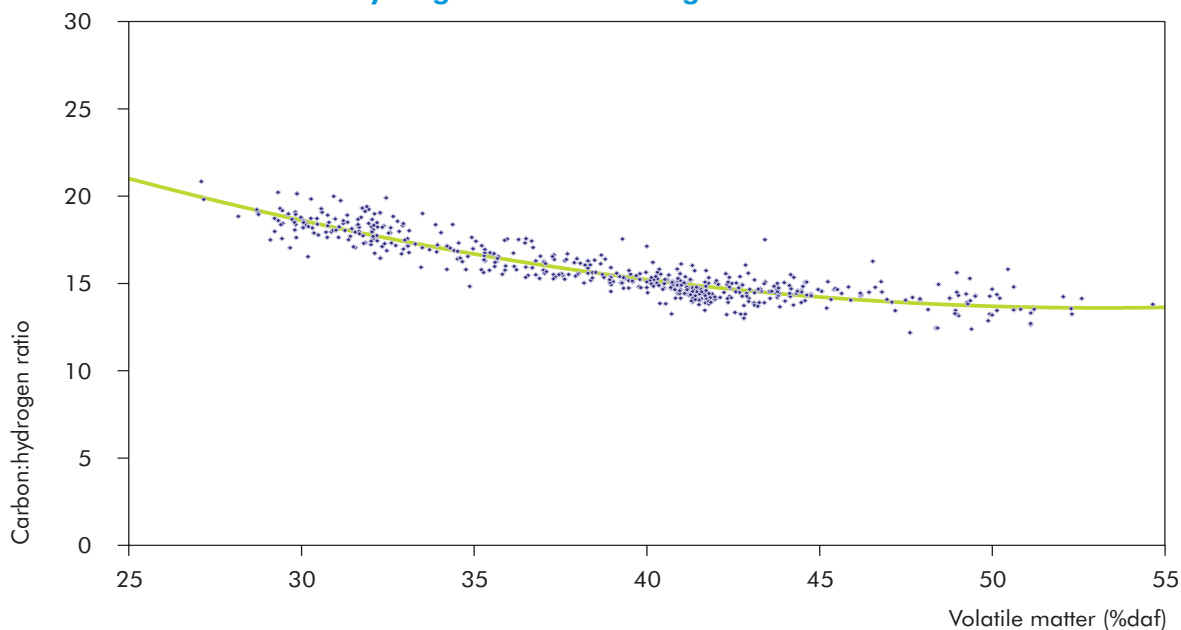
Figure 3.9: Dry, ash-free volatile matter as an indicator of carbon: hydrogen ratio for a large data set

Source: E.ON UK plc.

Figure 3.9 shows empirically that the dry, ash-free volatile content of a coal can provide a good indicator of its carbon-to-hydrogen ratio, and therefore its carbon intensity, assuming its calorific value is known. Table 3.7 shows typical carbon:hydrogen ratios for a variety of fuels.

Table 3.7: Typical carbon:hydrogen ratios for various fuels

Fuel	Typical C:H ratio
Anthracite	32.6
Bituminous coal	15.2
Sub-bituminous coal	14.9
Lignite	14.0
Biomass	8.3
Heavy fuel oil	7.5
Light fuel oi	7.3
Natural gas	3.1

Source: E.ON UK plc.

These empirical relationships, based on commonly known fuel properties, provide a basis for generic fuel-quality corrections to plant efficiency and specific CO₂ emissions data. For non-condensing plant designs, the quantity of fuel required is related to its net calorific value. The carbon released in providing that heat is related to the C:H ratio, and the overall carbon intensity can be related to the GCV:NCV ratio and the C:H ratio of the fuel. The C:H ratio, the gross calorific value of hydrogen relative to carbon (141.886 MJ/kg / 32.808 MJ/kg = 4.325), and the GCV:NCV ratio, which could be arbitrarily termed the “fuel carbon intensity factor”, can be combined to compare a range of different fuels without any need for detailed knowledge of fuel composition.

$$\text{fuel carbon intensity factor} = \text{GCV} / \text{NCV} / (1 + 4.325 / \text{C:H})$$

This is important when considering the specific CO₂ emission of a process. If this value is normalised with reference to one of the fuels of interest a “relative fuel carbon intensity factor” can be derived. This factor allows easy comparison of the impact of fuel quality on specific CO₂ emissions (effectively comparing the quantity of carbon burned for a given net heat input). These factors are shown calculated in Table 3.8 using information from tables above.

**Table 3.8: Relative carbon-intensity factors for various fuels
(with bituminous coal as the reference case)**

Fuel	GCV:NCV	C:H ratio	Fuel carbon intensity factor	Relative fuel carbon intensity factor
Anthracite	1.025	32.58	0.90	1.11
Lignite	1.159	13.97	0.88	1.09
Sub-bituminous coal	1.074	14.86	0.83	1.02
Wet biomass	1.250	8.32	0.82	1.01
Bituminous coal	1.045	15.22	0.81	1.00
Dry biomass	1.091	8.32	0.72	0.88
Heavy fuel oil	1.059	7.49	0.67	0.83
Light fuel oil	1.058	7.32	0.66	0.82
Natural gas	1.108	3.06	0.46	0.56

Source: E.ON UK plc.

It should be noted that this calculation is based on fuel properties and excludes the effects of plant design and performance, and the contribution of fuel production and supply on CO₂ emissions. It also excludes the potential impact of, for example, ash quantity, ash fusion properties and fuel reactivity variations on boiler performance (although these can be largely managed through appropriate design and operation). Literature suggests that, compared to bituminous coal-fired plants, the efficiencies of plants firing sub-bituminous coal and lignite are respectively about 5% and 10% lower on a NCV, net output basis. For example, a plant with steam conditions and cooling system suitable for achieving an efficiency of 45% with hard coal might only deliver 42.8% with sub-bituminous coal and 40.5% with brown coal or lignite on a NCV, net output basis.

Figure 3.10 illustrates the more general impact of coal moisture on overall unit performance when the combined effects of latent heat (GCV-NCV differential), alteration of flue gas dew point temperature (due to moisture in gas) and additional fan power (due to additional mass and volume flows) are taken into account. It should be noted that this has been derived for a relatively low-ash coal and efficiencies could well deteriorate more for high-ash coals. It should also be recognised that the curves will be affected by the sulphur content of the coal and its impact on dew point temperature (see below).

Figure 3.10: Approximate influence of coal moisture on plant efficiency

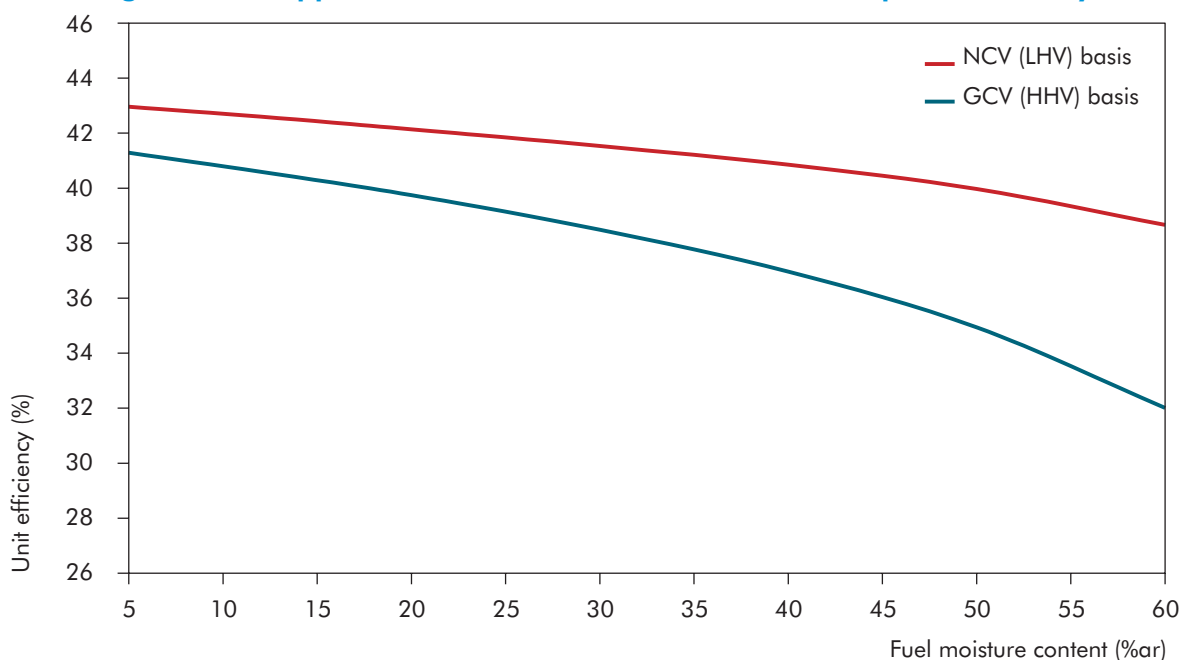

Source: E.ON UK plc.

New technologies for lignite-fired boilers address the effects of moisture by recovering heat lost from the steam cycle to dry incoming fuel. While this improves the efficiency of the plant, and leads to lower fuel consumption, it does not change the fact that lignite requires energy to dry it prior to combustion. For example, the low-grade heat used to dry lignite could be put to alternative use, such as district heating, if bituminous coal were used instead in the same boiler. Lignite is, however, a competitive and abundant fuel; its use is likely to continue in certain regions, and fuel drying will secure more output and lower emissions.

In the case of blended fuels, co-firing or the use of secondary fuels, the factors described above can be combined pro-rata, weighted by their gross heat contributions. Any carbon offset associated with the use of biomass fuels would need to be considered separately.

Steam conditions

As described above, the steam cycle boundary conditions have a significant impact on overall plant efficiency. In this respect, the temperatures and pressures of the main and reheat steam are major design considerations. Figure 3.11 provides a means to correct the heat consumption of single reheat cycles operating with different main steam and reheat conditions (all other factors being equal). This diagram does not extend to cycles using supercritical steam conditions of 350 bar, 700/720 °C which should offer heat rate improvements in the order of 14%. Such cycles are currently being investigated in Europe under the AD700 project and in the USA by the DOE and EPRI.

Figure 3.11: Heat rate improvement with main steam and single reheat temperature at different main steam pressures

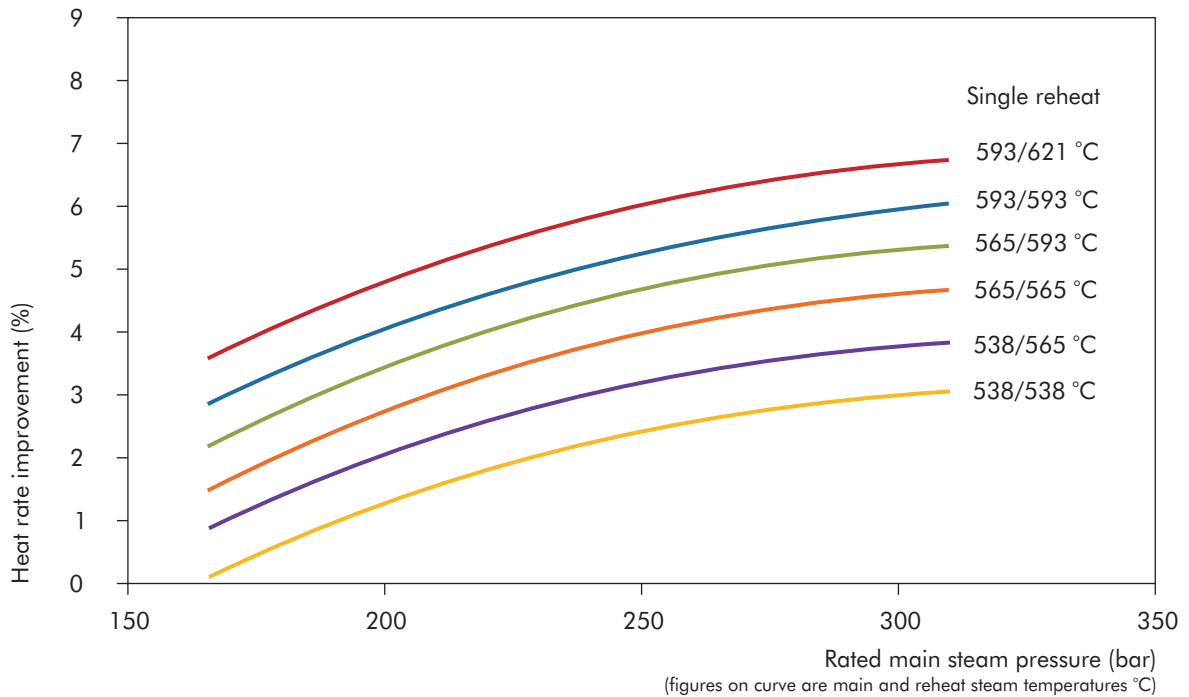

Source: Henderson (2004) after Logan and Nah (2002).

Using the curves above, an efficiency correction factor¹⁹ can be established based on superheat temperature, superheat pressure, the ratio of reheat temperature to superheat temperature and reference conditions of 160 bar, 565/565 °C for a single reheat cycle:

$$\text{correction} = 0.4292 + (0.000403 \times P) - (3.5 \times 10^{-7} \times P^2) + (0.000637 \times M) + (0.1548 \times R / M)$$

Where P is the main steam pressure (bar), M is the main steam temperature (°C), and R is the steam reheat temperature (°C).

This relationship should only be considered valid for the data in Figure 3.11. Steam conditions are a key design parameter for any power plant; once chosen, they largely determine the efficiency performance that can be expected at a particular site using a specified fuel. It is not proposed that corrections be made for steam conditions within the context of general efficiency reconciliation, unless it is specifically of interest.

¹⁹ corrected reference efficiency (%) = uncorrected as-reported efficiency (%) × efficiency correction factor

Reheat stages

Plants using reheat cycles are more efficient than those without reheat, and two stages of reheat are normally even more efficient, assuming its use can be justified economically. Non-reheat cycles were used in the past, but are not usually found in modern plants. Correction factors for efficiency, based on number of reheat stages, are shown in Table 3.9, assuming other factors remain constant. The reference case is one stage of reheat. Figure 3.12 illustrates the potential benefits of double reheat with higher steam conditions.

Table 3.9: Efficiency correction factors for number of reheat stages

Reheat stages	Correction factor
None	0.900
Single	1.000
Double	1.015

Figure 3.12: Heat rate improvement at different main steam pressure, with increasing main steam and double reheat temperatures

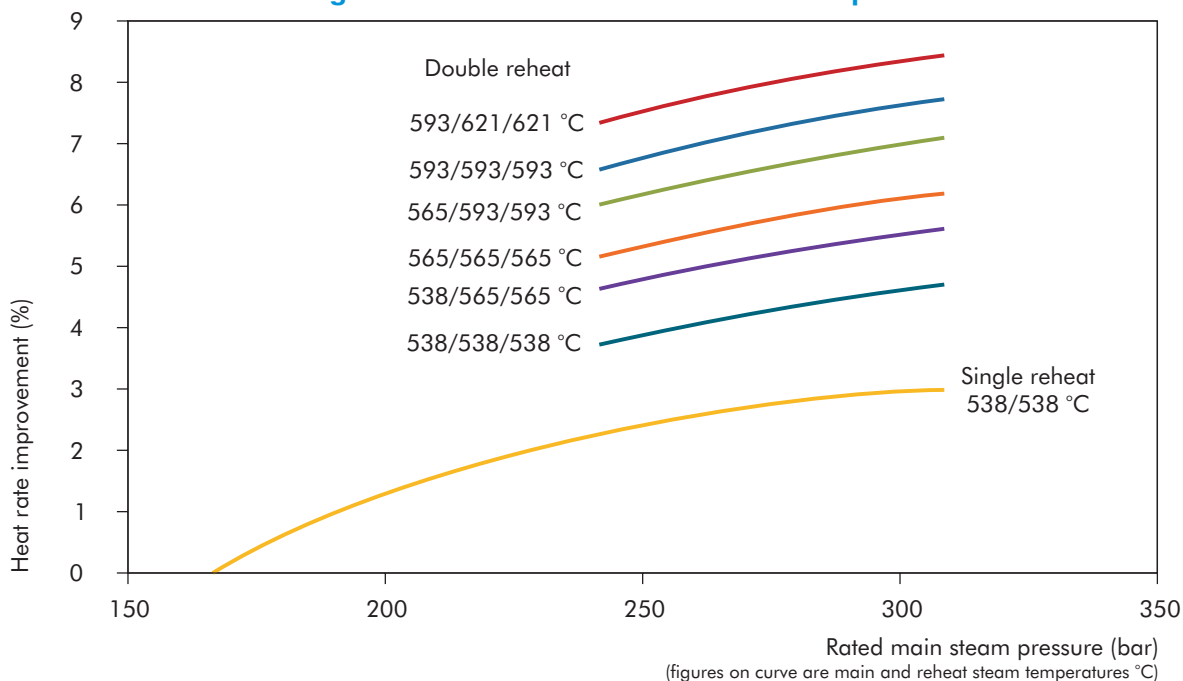

Source: GE Power Generation (1996). Reprinted by permission of the publisher. © GE Energy, 1996.

Cooling-water system

Seawater cooling generally allows the highest efficiencies to be achieved, especially for power plants adjacent to cool seas using once-through cooling systems. Once-through designs using river water also perform well, although the cooling-water temperatures tend to be higher. Constraints on water abstraction and use mean that it is common for inland stations to use closed-circuit cooling systems with cooling towers. These systems run with a higher cooling-water temperature in the recirculation system which lowers performance. In cases where water is scarce, dry-cooling systems may be used. Such systems are rarely employed because they result in a very significant efficiency penalty. In Table 3.10, corrections are proposed, based on the type of cooling system employed. The reference case is assumed to be an inland station with a wet cooling-tower system.

Table 3.10: Efficiency correction factors for type of cooling system employed

Cooling system type	Correction factor
Seawater (once-through)	1.024
River water (once-through)	1.015
Closed-circuit, wet tower	1.000
Closed-circuit, dry tower	0.952

Forced-ventilation cooling towers may be capable of achieving lower condenser pressures than natural-draught towers. However, their use offers no clear advantage after the associated power consumption has been taken into account, so no correction is proposed for forced-ventilation towers.

Ambient temperature

Cooling-water temperature will tend to be influenced by ambient temperature. Changes to ambient temperature will affect the boiler air to hot gas temperature rise, boiler radiation losses and fan power. The reducing boiler heat losses as ambient temperature increases will tend to be offset by worsening cooling system performance. For an ambient air temperature rise of say 10 °C, around 0.5% less fuel would be required to achieve the same hot gas temperature in the boiler. The impact of such a change in ambient temperature on cooling water would likely result in a 2% increase in heat rate – a net effect of +1.5%. It is therefore proposed that, where required, a nominal correction to heat rate of +0.15% per 1 °C increase in ambient temperature should be applied.

Ambient conditions can significantly affect the performance and load capability of gas turbines. This may be relevant for hybrid plants firing both natural gas and coal. Ambient temperature and pressure may also affect the performance of any plants employing air separation units for oxygen production.

Flue gas cleaning

Emissions control, such as flue gas treatment equipment, generally has an adverse impact on plant efficiency and CO₂ emissions (unless captured). From industrial experience, the heat-rate correction factors in Table 3.11 can be applied to “as-reported” plant efficiencies to account for the impact of commercial pollution control technologies.²⁰

Table 3.11: Heat rate correction factors for different gas treatment technologies

Technology employed	Correction factor
Wet FGD (compared with no FGD)	1.0200
Dry FGD (compared with no FGD)	1.0100
LNB and OFA	1.0050
SCR	1.0050
Bag filter (instead of ESP)	1.0050
SNCR	1.0025

Notes: ESP: electrostatic precipitators; FGD: flue gas desulphurisation; LNB: low-NOx burners; OFA: over-fire air; SCR: selective catalytic reduction of NOx, SNCR: selective non-catalytic reduction of NOx.

²⁰ corrected reference efficiency (%) = uncorrected as-reported efficiency (%) / heat-rate correction factor

Although not currently employed, a similar correction can also be made for CO₂ capture. This can be integrated into the calculations in a similar way to FGD, with a direct heat-rate penalty component and a second component associated with the CO₂ removal rate. In the case of applying CO₂ capture to a pulverised coal combustion plant, the heat-rate correction factor could be in the region of 1.2, based on current knowledge of the technology.

Fuel sulphur content and dew point

The fuel sulphur content will have some impact on the minimum flue gas temperature to avoid dew-point conditions and formation of corrosive acids. Very approximately, the minimum operating temperature to avoid the dew point for bituminous coals with average moisture can be related to sulphur and moisture content. This can then be converted into a change in boiler sensible heat loss.

To avoid the acid dew point, a flue gas temperature rise of 1 °C per 0.2% sulphur in coal, above a nominal level of 1% sulphur (dry basis), can be assumed; with a further 1 °C per 5 percentage point rise in the as-received moisture content. The recommended reference moisture level is 12%. This can be translated into a heat rate increase of approximately 0.3% per 1 percentage point change in sulphur, in addition to a 0.01% increase in heat rate per 1% moisture. Below 1% sulphur, the dew-point correction should only take account of moisture since power plants are rarely designed to accept only fuels of less than 1% sulphur. The true dew point relationships are complex, but the proposed approach provides a simple basis on which to make approximate corrections.

These corrections are distinctly separate from the impact of installing FGD to control sulphur dioxide emissions and the direct impact of moisture on fuel calorific value and sensible heat losses. The effect of fuel moisture is considered in Figure 3.10 and the impact of desulphurisation in Table 3.11.

Some power plants may use a low-sulphur coal, but then inject SO₃ to maintain electrostatic precipitator performance. In such situations, the potential benefits of reducing flue gas temperature when using low-sulphur coal may not be realised, since dew-point problems could persist as a result of the SO₃ injection. The SO₃ effectively raises the dew-point temperature back towards that found with a higher-sulphur coal.

Fuel ash content

Coal ash, an inert diluent, is generally a nuisance: higher levels of ash require the delivery and processing of more coal and the collection and transfer of more ash. The presence of more ash also requires the use of more soot blowing to remove ash deposits in the boiler furnace and convective heat transfer sections to maintain good heat transfer. Ash discharged from the furnace bottom and removed from the flue gas takes with it a quantity of sensible heat. There is therefore an additional energy penalty associated with the use of high-ash fuels, irrespective of their other properties. Firing high-ash coal on a plant not designed for such fuel can create performance problems (mainly associated with boiler heat transfer), although plants that are designed for these fuels can operate well and with high efficiency.

A small ash correction factor could be applied, where appropriate, proportional to the ash content. A figure of +0.03% on heat rate per 1 percentage point dry ash is proposed, based on a reference ash level of 12%. On this basis, the difference in heat rates between a plant using 8% dry ash fuel and an otherwise identical plant using 18% dry ash fuel would be 0.3%.

Auxiliary power

Auxiliary power requirements differ for various reasons, including the use of:

- electric driven boiler feed-water pumps;

- higher boiler pressures;
- different designs of coal pulverising plant;
- fuels with different densities, and hence volumes;
- different flue gas treatment technologies;
- modern motors and flow controls; and
- compressed air soot blowers.

Operation at part load, or with many start-ups and shutdowns, will increase the relative auxiliary power requirement. There are also differences in how auxiliary power is accounted for, since even large plant items, such as condenser cooling-water pumps and boiler feed-water pumps, can usually be driven from the station supplies (imported power) or the unit supplies (generated power). Such differences in power supply arrangements can influence efficiency significantly when calculated on a unit basis, but will have no effect on efficiency expressed on a whole-plant basis. This, and the inclusion of common plant energy requirements associated with fuel and ash handling, are good reasons to adopt a whole-plant efficiency evaluation basis.

Main boiler feed-water pumps are typically steam driven, with electric start-up and stand-by pumps. Although electric feed-water pumps can be used, their power consumption needs to be evaluated carefully to understand the impact on plant performance compared with steam-driven pumps. Overall efficiency is likely to be similar for either option, assuming that the plant is designed for one or the other from the outset. However, if a plant is designed for a steam-driven pump and then operates with electric pumps, this is generally detrimental to plant efficiency, since changes to the steam system affect both feed-water heating and steam flows to the main turbine and boiler reheater.

Other changes to auxiliary power are either insignificant or are already taken into account by corrections proposed elsewhere in this report. Typically, works power may range from 2.5% to as much as 8% of a unit's generated power, with high-end values applying to high-pressure supercritical units with electric-driven main boiler feed-water pumps, and low-end values to low-pressure units with steam-driven main boiler feed-water pumps and vertical-spindle coal mills.

Feed-water heating, reheater pressure loss and reheat spray

There are some key plant design parameters which influence plant performance, such as the number and position of feed-water heaters (which influence boiler feed-water temperature), the design pressure loss across the reheater and the quantity of reheat spray required. These are inherent to a power plant's design and therefore require no correction, since it is largely such design differences that are being assessed when comparing the performance of a particular plant against best practice. The same argument applies to the design steam temperature and pressure.

Generator power factor

Generator power factor has an impact on losses and heat rate. However, this effect is considered to be too small to justify correction here. Such a correction could be added, if required, but would require the submission of operational power factor information for each plant and a justification for why a correction might be needed.

Number of units and unit capacity

There are generally good practical and economic reasons to employ more than one power generation unit on a particular site and to build large units. Economies can be made by sharing facilities and resources (*e.g.* coal and ash plant, staff and spares holdings), and through the relatively lower cost of larger units of a given design.

Overall, the efficiencies of higher capacity units are better than those of smaller units, largely because they are more modern. Early power generation units were very small by today's standards and newer units have progressively increased in both size and technological advancement. If smaller generating units were installed today, then they would be very much more efficient than older units of the same size – it is important to differentiate between the impacts of plant age and plant size.

While larger plant will tend to have higher efficiencies, there are insufficient data available at this time to justify a reliable correction for plant size. Furthermore, it is considered that the efficiency impact of installing multiple small units, instead of a single large unit, has a negligible impact on plant efficiency, even though the impact on overall plant economics could be very significant.

Boiler radiation and “unaccounted” losses

Boiler radiation and “unaccounted” losses are usually agreed with the boiler supplier, and are often determined by reference to standard methods such as the charts by the American Boiler Manufacturers Association (ABMA). The losses are fairly constant when the plant is in operation, but become a relatively larger proportion of the heat input as load is reduced. Smaller plants, with larger surface-to-volume ratios, suffer more from these losses, although losses become progressively less sensitive to plant size as size increases. Large modern units would be expected to have losses of around 0.5% at average load, but this could rise to 3% for a small older unit (<100 MW) with low average operating load. For the purposes of this evaluation, it is assumed that the boiler radiation and unaccounted losses are reflected in the whole-plant efficiency such that changes in these losses with load are taken into account by whole-plant load correction factors. Related to these losses, however, is whether the plant is designed with or without a main building enclosure and the ambient environment in which it operates. Typically, for temperate climates, the losses might be expected to be 50% higher for external plant. It is therefore proposed that the reference case should be an indoor plant, with a small generic correction of +0.375% on heat rate applied to external plant – irrespective of plant size and average load.

Excess air and unburned carbon

Excess air and unburned carbon in ash are largely operational issues. Although they directly affect boiler thermal losses, these are controllable losses that can be managed at the site level; plant efficiency corrections are not required.

Controllable losses

In any operating power plant, peak performance may no longer be reached because of the condition of the plant. In some cases, a step change in performance may be observed. For example, a plant may be called on to operate with stand-by equipment in service, or may be configured in an abnormal way (*e.g.* with feed-water heaters out of service). Other effects may be more gradual and related to leakage, wear, lack of adjustment or control and instrumentation problems. Such losses can generally be rectified, but degrade the efficiency of the plant if left unchecked. They are difficult to predict, although they are generally higher as a plant approaches its routine overhaul. It is proposed that a blanket allowance of +1% on heat rate is made, where justified, to account for a “reasonable” time-averaged level of controllable losses compared to ideal performance.

4. EFFICIENCY OUTLOOK FOR POWER GENERATION FROM COAL

The need for energy, together with the economics of producing and supplying that energy to the end user, are central considerations in power plant investment decisions and operating strategies. Inevitably, there will be a point at which higher efficiency and lower emissions come at a cost which cannot be justified. Where economic and regulatory conditions exist which shift this balance consistently in favour of higher efficiency and lower emissions, improvements become a normal part of running a competitive business. The trend over time has been towards improved power plant performance.

Worldwide coal-fired power plant efficiency averaged 35.1% in 2007, compared with 33.5% in 1971.²¹ Figures 4.1, 4.2, 4.3 and 4.4 illustrate the evolution of efficiency in countries where coal is used widely for electricity generation and heat supply. This top-down assessment is based on annual coal consumption and electricity supply data collected by the IEA. The annual data (dashed lines) are smoothed by using five-year moving averages to show long-term trends (solid lines). Fuel energy input is on a net calorific value (NCV) or lower heating value (LHV) basis, while electricity output is on a gross basis (*i.e.* at the generator terminals, before any deduction for on-site electricity use), each being the basis adopted by the IEA for reporting energy statistics.²² Heat supply is based on the quantity of heat supplied under commercial arrangements; the gross-net concept has no meaning for heat supply. Efficiency is calculated after correcting for heat supply using the methodology adopted by the EU.²³ While this assessment allows comparison of coal-fired power generation efficiency at the national level, it does not allow performance comparisons to be made between individual plants; indeed, the IEA does not collect plant-level data.

Although drawing national comparisons is not the purpose of this report, some observations can be made on the four figures:

- The most rapid efficiency improvements have been seen during periods when large new coal-fired power plants were being built, for example in Japan, Korea and South Africa.
- In North America, much of the fleet of coal-fired power plants operating today was built during the 1960s, so efficiency performance has been largely unchanged over the last forty years. The availability of competitively priced indigenous coal and the need to retrofit pollution control equipment have not favoured efficiency improvements.

21 On a lower heating value, gross electrical output basis, after correction for heat supply. The average efficiency in 2007 is estimated to be 32.6% on a net output basis, assuming power plant own use of approximately 7%. The reported average efficiency would be lower if no correction were made for heat supply (see Figure 4.5).

22 Note that this report recommends that efficiency be reported on a fuel's gross calorific value (GCV) or higher heating value (HHV) basis, and a net electricity sent-out basis.

23 See footnote 8.

- In Europe, the trend of improving efficiency reflects the closure of older, less efficient coal-fired power plants, replaced either by new coal-fired plants or other energy sources for power generation such as natural gas, renewable sources and nuclear.
- Coal-fired power generation efficiency shows a gradual improvement in China as more new plants are built with improved performance.
- Countries which exploit poor quality coal for power generation are faced with lower levels of efficiency, for example in Australia and India. Many power plants in these two countries must also contend with high ambient temperatures and limited water supplies, both contributing to lower efficiency.
- The cogeneration of heat and power can improve efficiency, for example in Russia and Poland. However, this assumes that the heat supplied is used effectively.

Figures 4.1, 4.2, 4.3 and 4.4: Evolution of coal-fired heat and power plant efficiency in selected countries (annual data and five-year moving averages)

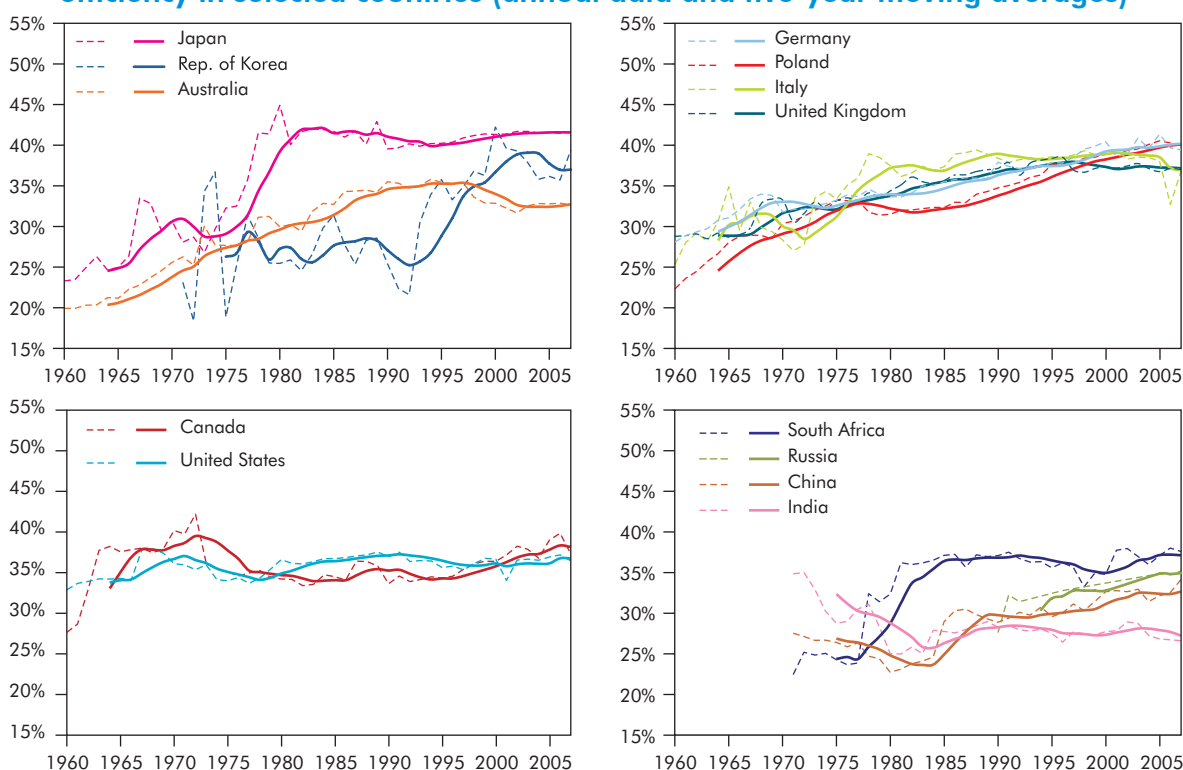

Notes: Annual data are shown with dashed lines, five-year moving averages with solid lines. For Russia, data are shown for 1990-1992, 1996 and 2005-2007. Data for the intervening years show inexplicable efficiency improvements and may need revising.

Source: IEA databases.

The data reported in Figures 4.1 to 4.4 are not corrected for any of the factors discussed in Section 3. As such, it is a “raw” comparison that ignores the influences of uncontrollable variables on performance, such as ambient temperature.

The development of supercritical and ultra-supercritical steam cycles, with progressively higher steam temperatures and pressures, combined with modern plant design and automation, provide significant potential for further efficiency improvements and the mitigation of CO₂ emissions when compared with existing coal-fired power plants. These improvements can be realised through the progressive replacement of existing assets with new plant designs that reflect best practices.

Although a large number of supercritical and ultra-supercritical pulverised coal-fired power plants are currently under construction or planned, subcritical technology has continued to dominate recent build. However, with stricter requirements to limit CO₂ emissions, the share of supercritical and ultra-supercritical plants should increase.

By far the largest energy loss from existing and future coal-fired power plants will remain the heat rejected from the steam cycle to the cooling water. The use of cogeneration or combined heat and power, along with district heating and cooling, has therefore received renewed interest in the light of requirements to improve energy efficiency and reduce specific CO₂ emissions. However, the most significant potential to reduce CO₂ emissions from coal-fired power plants will come through the application of CO₂ capture and storage. Here, basic plant efficiency improvements will be a significant factor in ensuring the viability of carbon capture.

Figure 4.5 shows projections by VGB for the efficiency of and emissions from coal-fired power generation by 2020. With proper policy and financial support for demonstration, by 2015 the net efficiency of state-of-the-art units firing hard or bituminous coal could reach 50% (LHV, or around 48% HHV) at plants without CO₂ capture and storage. For lignite-fired plants, these figures will be up to five percentage points lower depending on the moisture content of the coal, but that can be improved if developments in efficient coal-drying technology are successful, using either waste heat or low-grade steam.

Figure 4.5: Efficiency improvement potential at hard coal-fired power plants

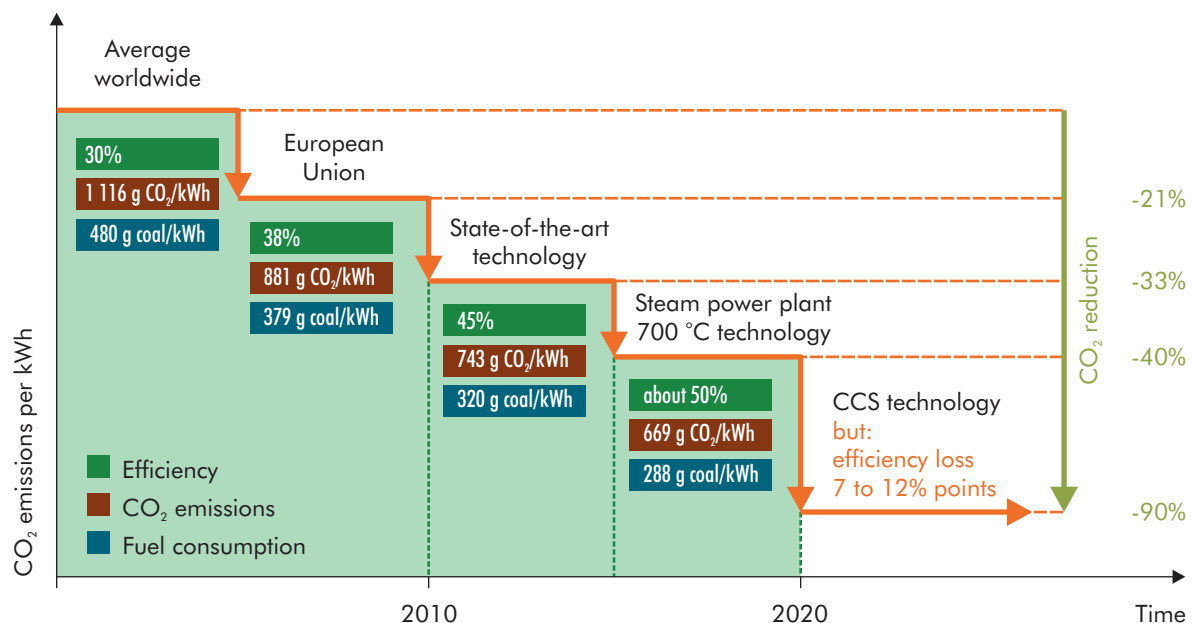

Source: VGB (2009). Reprinted by permission of the publisher. © VGB PowerTech e.V., 2009.

CO₂ capture will impact significantly on the efficiency of both existing and future plants. At the current state of technology, units retrofitted with capture would suffer a decrease in efficiency of up to 12 percentage points, and consume perhaps 20% to 30% more fuel per unit of electricity supplied. While a concept of what constitutes “capture-ready” exists for new power plants, it may not be economic or technically viable to retrofit existing pulverised coal plants with CO₂ capture, especially at smaller units. Refurbishments will often be necessary to improve efficiency at existing plants before CO₂ capture retrofits can be contemplated. If 40% efficiency were to be considered the cut-off for CO₂ capture retrofit, around 10% of the world’s

current coal-fired capacity would be suitable for CCS.²⁴ Even then, and assuming a route to storage, case-by-case analyses would be needed to assess whether existing control systems can be safely adapted and whether the large steam requirement of CO₂ capture equipment can be sensibly supplied from these existing plants.

Owing to the loss of efficiency, retrofitted units will deliver less power; additional new capacity would likely be needed to offset this loss. Based on new-build information, project proposals and forecasts it appears that while the majority of future plants will be either supercritical or ultra-supercritical, with an efficiency above 40%, subcritical units will still have a significant market share. By 2030, up to half of the fleet might be considered suitable for CCS retrofit when necessary, while most of the remaining plants would require either upgrading to deliver high efficiencies or total replacement.²⁵ Further work is needed to better define the future potential for CCS retrofit at coal-fired power plants.

24 Estimate using IEA Clean Coal Centre CoalPower5 database. Of the 7 173 units listed in the database, the individual efficiencies of a sample comprising 4 396 units (with a total capacity of 1 074 GW) has been estimated from available operating parameters. Of these units, 255 units (with a total capacity of 118 GW) are estimated to have an efficiency of greater than 40%.

25 Estimate from supercritical coal-fired power plants listed in Platts UDI *World Electric Power Plants Database 2009* and analysis presented in IEA *World Energy Outlook 2009*.

5. CONCLUSIONS AND RECOMMENDATIONS

The major conclusions and recommendations of this report build on those presented to the G8 Hokkaido Summit in July 2008 (IEA, 2008). These are summarised in this section, before a discussion of the way forward.

5.1 IEA recommendations to the 2008 G8 Summit

Coal is the least costly and most accessible fuel for some of the most dynamic developing economies. Its use at coal-fired power plants accounts for over 28% of global CO₂ emissions, a share that is rising. An absolute priority is to enhance plant efficiency, which can significantly reduce CO₂ emissions and the volume of coal consumed. Available technology can deliver fuel savings of 50%.

Worldwide coal-fired power plant efficiency averages around 33% (LHV, net output). Implementation of the suggested measures from IEA work carried out in support of the G8 Gleneagles *Plan of Action* could result in the replacement of some 300 GW and retrofit of some 200 GW of older coal-fired power plant capacity, while ensuring that all new plants are state-of-the-art. This could, if fully implemented, lead to a reduction of up to 1.7 Gt per annum of CO₂ emissions – which is roughly one-quarter of annual CO₂ emissions from coal-fired heat and power production – and a reduction in coal consumption of at least 0.5 Gt per annum.

To improve the operating efficiency of the global fleet of coal-fired power plants – and thereby significantly reduce CO₂ emissions – the IEA recommends that governments focus on the following policy approaches:

- New coal-fired power plants should be >40% efficient.²⁶ Governments should look to replace by 2020 those coal-fired power plants built over 25 years ago and <300 MW. All other coal-fired power plants should be assessed for upgrading or replacement to achieve around 40% efficiency.
- International co-operation, training and financing mechanisms should be focussed on achieving the above best-practice efficiency objectives in the design, operation and maintenance of coal-fired power plants and electricity grids.
- The development and demonstration of those technologies that target higher efficiency at coal-fired power plants should be accelerated. For example, advanced materials, coal cleaning and drying, co-generation of heat and power, and more efficient CO₂ capture technologies all need to be deployed.

In addition to these efficiency improvements, the deployment of CO₂ capture and storage (CCS) technology is vital. The aim of reducing CO₂ emissions by 50% by 2050 implies that virtually all coal-fired power plants will need CCS by then (including some under construction now). Based on IEA recommendations, G8 governments strongly support the launching of twenty fully integrated industrial-scale CCS demonstration projects globally, with a view to beginning broad deployment of CCS by 2020. The IEA further recommends

26 On a higher heating value, net electrical output basis. On a lower heating value basis, the figure is approximately 42%.

that any developer of a new coal-fired power plant should consider now what might be required to retrofit CCS. In 2009, at the request of G8 leaders, the IEA launched a CCS technology roadmap that presents a detailed scenario for the deployment of CCS technologies, from a handful of demonstration projects to over three thousand projects by 2050 (IEA, 2009). The contribution of CCS to reducing global emissions under this scenario is significant: by 2050, CCS contributes almost one-fifth of the necessary emissions reduction to achieve stabilisation of atmospheric GHG concentrations in the most cost-effective manner.

5.2 Reporting efficiency performance

An understanding of the technical potential to improve efficiency is key to developing leading-edge technologies, implementing policies to encourage their widespread adoption and taking corporate investment decisions that see them deployed. Yet, the factors discussed in this report have illustrated how the same level of plant performance can be described by a confusingly wide range of efficiency values, depending on the bases used for their calculation and reporting. For example, quoted efficiencies of new plants operating at design conditions cannot be compared with efficiencies of typical plants operating under constrained or off-design conditions.

At present, there is no common standard for collecting and compiling coal-fired power plant efficiencies or specific CO₂ emissions. Hence, there is no basis to compare the operational performance of power plants or to identify the potential for improvements. A means should be established to compare the performance of individual plants with best-practice performance.

Unfortunately, defining a new comprehensive methodology to rationalise plant efficiency reporting is not a practical proposition given the many different reporting bases and assumptions already in use around the world. Instead, a range of approximate corrections is proposed, requiring only limited information that can be collected even where the detailed bases of the original calculations are not known. Average figures, reported over a timescale of one month or more, will be inherently more reliable, reflecting the actual efficiency achieved more accurately than design values, performance guarantees or short-term tests under ideal conditions. The corrected data can then be compared with data for plants adopting best practices.

Care still needs to be taken to distinguish between real design constraints and controllable variables; applying corrections for every variable would ultimately lead to all plants appearing to have the same efficiency. This report has described a calculation methodology and estimated correction factors to reconcile performance data. In the context of evaluating overall plant efficiency and specific CO₂ emissions, the errors introduced using this approach will be small compared to the differences in power plant efficiencies between typical plants and state-of-the-art ones, and between current and future potential. The approach outlined may not therefore be the most accurate, but forms a pragmatic and practical means of comparing plant efficiencies reported from different sources.

5.3 Improved collection of performance data

An essential part of sound policy development is the rigorous analysis of information which should be internally consistent and verifiable. Reliable power plant operating information is not easy to obtain, whether on a unit or whole-plant basis, particularly efficiency-related information such as coal quality, coal consumption and electricity generation. It is therefore proposed that an international database of annual average coal-fired power unit operating information should be established for the purposes of determining, monitoring, projecting, reporting and comparing coal-fired power plant efficiencies and specific CO₂ emissions. Such a database could be maintained by the IEA Energy Statistics Division or by the IEA Clean Coal Centre Implementing Agreement (IEA CCC) as an extension of its existing CoalPower5 database of world coal-fired power plants.

The regular updating of such a data-collection system would require manpower resources in addition to those that are currently employed to maintain the IEA CCC database. Although the general concept and outline of such a scheme is proposed in this report, the specific arrangements for data submission, processing and access would require further discussion and agreement with IEA member countries and non-member countries.

For such a system to work, there must be a clear responsibility on plant operators to submit data, rather than on the database operator to collect it. Participating countries could provide the required data through national government bodies, collected from operators of power plants above a defined minimum thermal capacity of say 50 MWth. These new reporting requirements would, in most cases, only require minor changes to existing reporting mechanisms, and the extent of data required on an annual basis would not be onerous. There would, however, be a fundamental requirement for every plant to monitor total energy input and output over the course of each year. Although this is standard practice for most plants, there may be some installations where additional monitoring equipment or procedures will be required.

Regional coverage of the scheme is a matter for further consideration. Clearly, the benefits of increasing the efficiency of the fleet of coal-fired power plants will be greatest in countries and regions with the largest demand and potential for investment, including China, North America, the European Union, India and Russia. However, the benefits of such a scheme would be evident in any country or region in which its implementation is possible.

Since most governments already collect energy data for statistical purposes, it should be relatively simple to extend systems already in place. Governments would need to decide on whether the availability and provision of such data should be mandatory for plant operators. They would also need to reach agreement on whether information should be published on a unit, plant, company or national basis, and on any criteria for exclusion. It may be that more detailed, unit-specific data could be collected for confidential use.

5.4 Performance benchmarking

In order to be useful in its underlying aim of encouraging best practice in coal use and understanding the potential for further improvement, an agreed view of best-practice performance would be needed. This should reflect efficiency and specific CO₂ emissions at a number of exemplary coal-fired power plants, covering different plant designs and operating conditions. These best-practice performance figures may then be used as benchmarks, providing a basis for participating countries to consult with industry to determine appropriate future development strategies that reflect regional constraints and objectives. It should be recognised that the most efficient plant may not necessarily be the most economic plant to build, own and operate, or provide the best long-term security of supply. A better understanding of plant performance allows decision makers to better address the compromises that must be made.

5.5 The way forward

Policy makers must reflect on what steps are now needed to improve the overall efficiency of power generation from coal. This report presents the tools for analysis and makes recommendations on how to use these tools to compare performance. This will allow poorly performing plants to be identified, wherever they are located. The costs and benefits of refurbishing, upgrading or replacing these plants can be estimated as the first stage in developing new policies that would encourage greater efficiency. The prize is large: some estimates suggest that 1.7 GtCO₂ could be saved annually. However, securing this reward would demand a major realignment of national energy and environmental policies, a realignment that may be less politically acceptable than allowing old, inefficient coal-fired power plants to continue running, in the hope that they will eventually fade away. Given that there appears to be no prospect of meeting global electricity demand without coal, governments must implement policies that respond more proactively to the growing use of coal, rather than wishing it away. Monitoring the efficiency of power plants and targeting those that perform poorly would be a step in that direction.

REFERENCES AND BIBLIOGRAPHY

- AGO (Australian Greenhouse Office) (2000a), *Integrating Consultancy – Efficiency Standards for Power Generation*, Report No. HA00316.0, Sinclair Knight Merz Pty. Ltd. for AGO, Canberra, ACT, Australia, January, www.environment.gov.au/settlements/ges/publications/skmreport.html.
- AGO (2000b), *Final Report: Powering into the New Millennium*, Efficiency Standards for Power Generation Working Group, AGO, Canberra, ACT, Australia, February, www.environment.gov.au/settlements/ges/publications/final_working_group.html.
- AGO (2006), *Technical Guidelines – Generator Efficiency Standards*, AGO, Department of the Environment and Heritage, Canberra, ACT, Australia, December, www.environment.gov.au/settlements/ges/publications/technical.html.
- ASME (American Society of Mechanical Engineers) (1991), *Steam-Generating Units*, ASME PTC 4.1-1964 (1991), ASME, New York.
- ASME (1997), *Performance Test Code on Overall Plant Performance*, ASME PTC 46-1996, ASME, New York, 15 October.
- ASME (1998), *Fired Steam Generators*, ASME PTC 4-1998, ASME, New York.
- ASME (2004), *Steam Turbines*, ASME PTC 6-2004, ASME, New York.
- BERR (Department of Business, Enterprise and Regulatory Reform) (2006), *Advanced Power Plant Using High Efficiency Boiler/Turbine*, Best Practice Brochure BPB010, DTI/Pub URN 06/655, DTI Carbon Abatement Technologies Programme, BERR, London, January.
- BGR (Bundesanstalt für Geowissenschaften und Rohstoffe – Federal Institute for Geosciences and Natural Resources) (2009), *Reserves, Resources and Availability of Energy Resources – Annual Report 2009*, BGR, Hannover, Germany, www.bgr.bund.de.
- BSI (British Standards Institution) (1974), *Code for Acceptance Tests on Stationary Steam Generators of the Power Station Type*, BS 2885:1974, BSI Group, London, September.
- BSI (2003), *Water-Tube Boilers and Auxiliary Installations: Acceptance Tests*, BS EN 12952-15:2003, BSI Group, London, October.
- BSI (2006a), *Greenhouse Gases. Specification with Guidance at the Organization Level for Quantification and Reporting of Greenhouse Gas Emissions and Removals*, BS ISO 14064-1:2006, BSI Group, London, March.
- BSI (2006b), *Greenhouse Gases. Specification with Guidance at the Project Level for Quantification, Monitoring and Reporting of Greenhouse Gas Emission Reductions or Removal Enhancements*, BS ISO 14064-2:2006, BSI Group, London, March.
- BSI (2006c), *Greenhouse Gases. Specifications with Guidance for the Validation and Verification of Greenhouse Gas Assertions*, BS ISO 14064-3:2006, BSI Group, London, March.

- BSI (2007), *Greenhouse Gases. Requirements for Greenhouse Gas Validation and Verification Bodies for Use in Accreditation or Other Forms of Recognition*, BS ISO 14065:2007, BSI Group, London, May.
- Burghardt, M. D. (1982), *Engineering Thermodynamics with Applications*, 2nd edition, Harper and Row, New York.
- CEGB (Central Electricity Generating Board) (1988a), "Plant Performance and Optimisation", internal report, CEGB, Barnwood, UK.
- CEGB (1988b), "Station Technical Heat Account and Thermal Losses Scheme", internal report, CEGB, Barnwood, UK, April.
- Chew, P. E. (2003), "PF-Fired Supercritical Power Plant", Proceedings of the Institution of Mechanical Engineers, *Part A: Journal of Power and Energy*, Vol. 217, No. 1, Professional Engineering Publishing, London, pp. 35-43.
- CIAB (Coal Industry Advisory Board) (2008), *Clean Coal Technologies: Accelerating Commercial and Policy Drivers for Deployment*, CIAB, International Energy Agency, Paris.
- CSA (Canadian Standards Association) (2007), *Canadian GHG Challenge Registry Guide to Entity and Facility-Based Reporting*, version 6.0, CSA, Ottawa, Canada, October, www.ghgregistries.ca/assets/pdf/Challenge_Guide_E.pdf.
- Defra (Department for Environment, Food and Rural Affairs) (2008), *2008 Guidelines to Defra's GHG Conversion Factors: Methodology Paper for Transport Emission Factors*, Defra, London, July.
- DFID (Department for International Development) (2000), "A Guide to Improving the Efficiency of Coal-Fired Power Plant in India", DFID Project No. R6844, AEA Technology, Harwell, UK, 97 pp.
- DIN (Deutsches Institut für Normung e.V.) (1994), *Abnahmeversuche an Dampferzeugern (Acceptance Testing of Steam Generators)*, VDI-Dampferzeugerregeln (VDI Rules for Steam Generators), DIN 1942, DIN, Germany.
- Ecofys (2007), *International Comparison of Fossil Power Efficiency*, Project No.: PECSNL073152, Ecofys, (for Central Research Institute of Electric Power Industry (CRIEPI), Japan), Utrecht, The Netherlands, August.
- E.ON UK (1995), "Efficiency of PF Plant", Powergen Technical Memo PT/95/BA564/M, P. E. Chew, E.ON UK plc, Nottingham, UK.
- EPA (US Environmental Protection Agency) (2010), *Inventory of US Greenhouse-Gas Emissions and Sinks 1990-2008*, Report No. EPA 430-R-10-006, EPA, Washington, DC, 15 April.
- Fenton, K. (1966), *Thermal Efficiency and Power Production*, Pitman, London.
- G8 (2005), *Gleneagles Communiqué on Africa, Climate Change, Energy and Sustainable Development*, G8, Gleneagles, UK, 8 July.
- GHG Protocol (Greenhouse Gas Protocol Initiative) (2005), *Calculation Tool for Direct Emissions from Stationary Combustion*, version 3.0, prepared by M. Gillenwater, Environmental Resources Trust for World Business Council for Sustainable Development and World Resources Council, July, www.ghgprotocol.org/downloads/calcs/Stationary_Combustion_Guidance_final.pdf.
- Gill, A. B. (1984), *Power Plant Performance*, Butterworths, London.
- Henderson, C. (2003), *Improving Efficiencies of Coal-Fired Power Plants in Developing Countries*, Report No. CCC/70, IEA Clean Coal Centre, London.
- Henderson, C. (2004), *Understanding Coal-Fired Power Plant Cycles*, Report No. CCC/91, IEA Clean Coal Centre, London.
- IEA (International Energy Agency) (2007), *Fossil Fuel-Fired Power Generation: Case Studies of Recently Constructed Coal- and Gas-Fired Power Plants*, OECD/IEA, Paris.
- IEA (2008), *Towards a Sustainable Energy Future: IEA Programme of Work on Climate Change, Clean Energy and Sustainable Development*, IEA, Paris, www.iea.org/G8/2008/G8_Towards_Sustainable_Future.pdf.

- IEA (2009), *Technology Roadmap: Carbon Capture and Storage*, IEA, Paris.
- IPCC (Intergovernmental Panel on Climate Change) (1997), *Revised 1996 IPCC Guidelines for National Greenhouse Inventories*, J. T. Houghton, L. G. Meira Filho, B. Lim, K. Tréanton, I. Mamaty, Y. Bonduki, D. J. Griggs and B. A. Callander (eds.), IPCC/OECD/IEA, Paris, France.
- IPCC (2006), *2006 IPCC Guidelines for National Greenhouse Gas Inventories*, prepared by the National Greenhouse Gas Inventories Programme, H. S. Eggleston, L. Buendia, K. Miwa, T. Ngara and K. Tanabe (eds.), Institute for Global Environmental Strategies, Hayama, Japan.
- ISO (International Organization for Standardization) (2006), *Greenhouse Gases – Part 1: Specification with Guidance at the Organization Level for Quantification and Reporting of Greenhouse Gas Emissions and Removals*, ISO 14064-1:2006, ISO, Geneva, Switzerland, 1 March.
- ISO (2009), *Quantities and Units - Part 1: General*, ISO 80000-1:2009, ISO, Geneva, Switzerland, 15 November.
- IUPAC (International Union of Pure and Applied Chemistry) (2006), “Atomic Weights of the Elements 2005”, IUPAC Technical Report, *Pure and Applied Chemistry*, Vol. 78, No. 11, pp.2051-2066, IUPAC, NC.
- Lang, F. D. (2009), “Discord in Boiler Efficiency Standards and Calorimetric Temperature”, unpublished paper, Exergetic Systems Inc., San Rafael, CA, 4 March, www.exergeticsystems.com/Papers/PAPER-59SUPPLEMENT.pdf, accessed 3 May 2010.
- Lightfoot, H. D. (2007), “Understand Three Different Scales for Measuring Primary Energy and Avoid Errors”, *Energy*, Vol. 32, Issue 8, Elsevier, pp. 1478-1483.
- Logan, T. M. and Nah U.-H. (2002), “Tanguin 5 and 6: Korea’s first ultrasupercritical units”, *Modern Power Systems*, 22 (10), pp. 23-25, October, Progressive Media Group Ltd., Sidcup, UK.
- McGurl, G. V., R. E. James, E. L. Parsons, J. A. Ruether and J. G. Wimer (2004), *Quality Guidelines for Energy System Studies*, Office of Systems and Policy Support, National Energy Technology Laboratory, Pittsburgh, PA, 24 February.
- Mills, S. (2005), *Coal Full Life Cycles Analysis*, Report No. CCC/99, IEA Clean Coal Centre, London.
- Nalbandian, H. (2007), *European Legislation (Revised LCPD and EU ETS) and Coal*, Report No. CCC/121, IEA Clean Coal Centre, London.
- NEI (Nuclear Energy Institute) (2007), *Comparative Measures of Power Plant Efficiency*, NEI, Washington, DC.
- Priest, C. W. (1947), *Power Station Efficiency*, Pitman, London.
- Retzlaff, K. M. and W. A. Ruegger (1996), *Steam Turbines for Ultrasupercritical Power Plants*, GER-3945A, GE Power Generation, Schenectady, NY, August.
- UNECE (United Nations Economic Commission for Europe) (1992), *Code of Uniform Standards and Procedures for the Performance of Draught Surveys of Coal Cargoes*, ECE/ENERGY/19, Working Party on Coal, Committee on Energy, UNECE, Geneva, Switzerland, 3 February.
- VDI (*Verein Deutscher Ingenieure* – Association of German Engineers) (2000), *Ermittlung des Wirkungsgrades von konventionellen Kraftwerken (Determination of Efficiencies of Conventional Power Stations)*, VDI 3986, VDI, Düsseldorf, Germany, October.
- VGB (2009), *Electricity Generation: Facts and Figures 2009/2010*, VGB PowerTech e.V., Essen, Germany.
- White, L. C. (1991), *Modern Power Station Practice – Volume G: Station Operation and Maintenance*, 3rd edition, British Electricity International, Pergamon Press, Oxford, UK.

ACRONYMS, ABBREVIATIONS AND UNITS²⁷

ABMA	American Boiler Manufacturers Association
AGEB	AG Energiebilanzen e.V.
AGO	Australian Greenhouse Office
ar	as-received (coal)
ARE	<i>Agencja Rynku Energii S.A.</i> (Energy Market Agency, Poland)
ASME	American Society of Mechanical Engineers (US)
ASTM	American Society for Testing and Materials (US)
AUD	Australian dollar
bar	unit of pressure (10 ⁵ Pa)
BERR	Department of Business, Enterprise and Regulatory Reform (UK)
BGR	<i>Bundesanstalt für Geowissenschaften und Rohstoffe</i> (Federal Institute for Geosciences and Natural Resources, Germany)
BImSchV	<i>Bundes-Immissionsschutzverordnung</i> (German federal emission control regulation)
BS	British Standard
BSI	British Standards Institution (UK)
Btu	British thermal unit
C	carbon
°C	degree Celsius (or centigrade)
CAAA	Clean Air Act Amendments of 1990 (US)
CaCO₃	calcium carbonate (limestone)
CCS	carbon (dioxide) capture and storage
CEA	Central Electricity Authority (India)

²⁷ See unit converter at www.iea.org/stats/unit.asp.

CEGB	Central Electricity Generating Board (UK)
CEM	continuous emissions monitoring
CEN	<i>Comité Européen de Normalisation</i> (European Committee for Standardization)
CIAB	IEA Coal Industry Advisory Board
CO₂	carbon dioxide
CO₂e	carbon dioxide equivalent (of GHG)
CV	calorific value (also known as heating value)
daf	dry, ash-free (coal)
DECC	Department of Energy and Climate Change (UK)
Defra	Department for Environment, Food and Rural Affairs (UK)
DEHSt	<i>Deutsche Emissionshandelsstelle</i> (German Emissions Trading Authority)
DFID	Department for International Development (UK)
DIN	<i>Deutsches Institut für Normung e. V.</i> (German Institute for Standardization)
DNV	Det Norske Veritas (Norway)
DOE	US Department of Energy
EC	European Commission
EIA	Energy Information Administration (US)
EPA	US Environmental Protection Agency
EPRI	Electric Power Research Institute (US)
ESP	electrostatic precipitator
ESWG	Efficiency Standards Working Group (Australia)
ETS	EU Emissions Trading Scheme
EU	European Union
FEPC	Federation of Electric Power Companies (Japan)
FERC	Federal Energy Regulatory Commission (US)
FGD	flue gas desulphurisation
g	gramme
G8	Group of Eight (Canada, France, Germany, Italy, Japan, Russia, UK, US)
gce	gramme of coal equivalent
GCV	gross calorific value
GE	General Electric Inc.
GES	Generator Efficiency Standards (Australia)

GHG	greenhouse gas
GIOS	<i>Główny Inspektorat Ochrony Środowiska</i> (Chief Inspectorate for Environmental Pollution)
GJ	gigajoule (10 ⁹ joules)
GOST	<i>gosudarstvennyy standart Rossii</i> (Russian national technical standard)
Gt	gigatonne (10 ⁹ metric tonnes or billion tonnes)
GWh	gigawatt-hour (10 ⁹ watt-hours)
GWP	global warming potential (of a GHG)
GUS	<i>Główny Urząd Statystyczny</i> (Central Statistical Office, Poland)
H	hydrogen
HHV	higher heating value
HR	heat rate
HRSG	heat recovery steam generator
IEA	International Energy Agency
IEA CCC	IEA Clean Coal Centre
IGCC	integrated gasification combined cycle
I/O	input/output (method of calculating power plant efficiency)
IPCC	Intergovernmental Panel on Climate Change
IPPC	Integrated Pollution Prevention and Control [Directive] (EU)
ISO	International Organization for Standardization
IUPAC	International Union of Pure and Applied Chemistry
K	kelvin (unit of temperature)
KASHUE	<i>Krajowy Administrator Systemu Handlu Uprawnieniami</i> (National Administration of the Emissions Trading Scheme, Poland)
KEMCO	Korea Energy Management Corporation
KETEP	Korea Institute of Energy Technology Evaluation and Planning
kg	kilogram
kJ	kilojoule (10 ³ joules)
kWh	kilowatt-hour (10 ³ watt-hours)
lb	pound (unit of mass)
LCPD	EU Large Combustion Plants Directive
LHV	lower heating value
LNB	low-NO _x burner

LOI	loss on ignition (of ash mass)
m³	cubic metre
mbar	millibar (10 ⁻³ bar)
MCR	maximum continuous rating
METI	Ministry of Economy, Trade and Industry (Japan)
mg	milligram
MJ	megajoule (10 ⁶ joules)
MMBtu	million Btu
Mt	million tonnes
MW	megawatt (10 ⁶ watts)
MWe	megawatts electrical
MWh	megawatt-hour (10 ⁶ watt-hours)
MWth	megawatts thermal
NCV	net calorific value
NETCEN	National Environmental Technology Centre (UK)
NETL	National Energy Technology Laboratory (US)
NIST	National Institute of Standards and Technology (US)
Nm³	normal cubic metre (of a gas)
NO_x	oxides of nitrogen
NPI	National Pollution Inventory (Australia)
NTPC	National Thermal Power Corporation (India)
OFA	over-fire air (used in a boiler)
O/L	output/loss (method of calculating power plant efficiency)
O&M	operation and maintenance
Pa	pascal (unit of pressure)
PC	pulverised coal (also referred to as pulverised fuel)
pf	pulverised fuel
PI	pollution inventory (UK)
PLF	plant load factor
PM₁₀	particulate matter <10 µm
PTC	Performance Test Codes (ASME)
Rosstat	Federal State Statistics Service (Russia)

SC	supercritical (steam)
SCR	selective catalytic reduction
SEB	State Electricity Board (India)
SHR	station heat rate
SNAP 97	Selected Nomenclature for Air Pollution (adopted in 1997)
SNCR	selective non-catalytic reduction
SO	sent-out (electricity)
SO₂	sulphur dioxide
SO₃	sulphur trioxide
STEP	Station Thermal Efficiency Performance (CEGB, UK)
t	metric tonne (1 000 kg)
tce	tonne of coal equivalent
UK	United Kingdom
UNECE	United Nations Economic Commission for Europe
UNFCCC	United Nations Framework Convention on Climate Change
URE	<i>Urząd Regulacji Energetyki</i> (Energy Regulatory Office, Poland)
US	United States
USC	ultra-supercritical (steam)
VDI	<i>Verein Deutscher Ingenieure</i> (Association of German Engineers)
VGB	VGB PowerTech e.V., a European technical association for power and heat generation (formerly <i>Verband der Großkraftwerks-Betreibe</i> – Association of Large Power Plant Operators)
VM	volatile matter (of coal)
WBCSD	World Business Council on Sustainable Development
WRI	World Resources Institute

APPENDIX I: UNDERSTANDING EFFICIENCY IN A POWER STATION CONTEXT

The following notes discuss the concepts and complexities of defining efficiency and some of the fundamental difficulties which may arise in efficiency analyses. They illustrate that the treatment of energy and efficiency is not as straightforward as it might initially appear, even before any of the more detailed technical considerations associated with process design, performance variability and measurements have been taken into account.

Energy supply chain

The assessment of performance, efficiency and emissions related to energy utilisation activities are complex and require constraining with identifiable system boundaries to enable a clear and consistent approach to be followed.

Figure I.1: Typical sequence of events in fuel utilisation

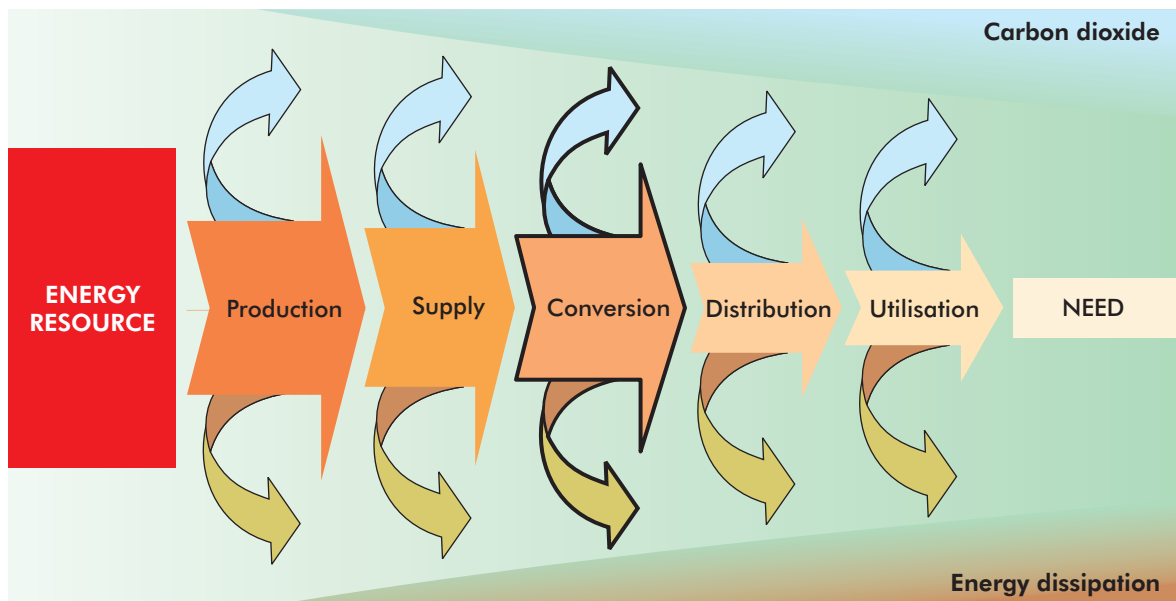

Source: E.ON UK plc.

Consider a coal-fired power plant as an example. Fuel must first be sourced, mined, processed, shipped, delivered and converted into electricity or heat for distribution to the end user, who consumes the supplied energy to meet a particular need (Figure I.1). In terms of overall CO₂ production and energy efficiency, it can be argued that it is actually the whole sequence of events, from sourcing the initial fuel to the energy service enjoyed by the end user that is important. The conversion efficiency of the power plant is only one element of a much bigger picture.

In order to assess power plant performance and specific CO₂ emissions, it is necessary to concentrate on the conversion process. This does not mean that the other links in the energy chain should be ignored: they all have critical roles to play in energy conservation and environmental protection.

What is efficiency?

In general terms, efficiency is the output of a process compared to the input. It can, for example, be defined in terms of “economic efficiency”, “operational efficiency” or “energy efficiency”. Economic efficiency is essentially the specific cost of producing useful output, and tends to be the main driver behind shaping process plant design and operation. Although energy efficiency is considered in the analysis of economic efficiency, it is quite possible for plants with low energy efficiency to also have high economic efficiency. Operational efficiency is generally called “capacity factor” or sometimes “load factor” and measures the actual output from a process compared to the potential maximum output. This is less important in business terms than economic efficiency, but is still a major performance indicator. Energy efficiency is the efficiency indicator which is familiar to most people and is a measure of the useful energy from a process relative to the energy input. Strictly speaking, energy efficiency refers to the ratio of useful work output to the heat input, so it may be more correct to use “energy conversion efficiency” when considering mixed inputs and outputs which may be in different energy forms.

For power generation plant using fossil fuels, the inputs are typically electrical power and heat (*i.e.* chemical) energy and the outputs are electrical power and sometimes useful heat. Although energy efficiency is often expressed as a percentage, it is also frequently referred to as “heat rate”. Heat rate is the quantity of heat required to produce a given output and therefore a lower heat rate is more efficient and gives a higher percentage efficiency. The relationship most frequently used for heat rate and efficiency in respect of electrical power generation is:

$$\text{efficiency} = 3\,600 / \text{heat rate}$$

Where heat rate is measured in kJ/kWh, MJ/MWh or GJ/GWh.

For example, a plant with a heat rate (*i.e.* heat consumption rate) of 9 000 kJ/kWh of output would have an energy efficiency of 40%. A 1% change in heat rate would change heat consumed by 1% but would only change the efficiency value by 0.4 percentage points. It is a common error to assume that a 1 percentage point change in efficiency is a 1% change in heat consumption and it is not unusual for sources of data which refer to and discuss efficiency to confuse these two measures.

Energy related analyses often refer to terms such as thermal efficiency, gross, net, isentropic efficiency, efficacy, exergy, energy and other terms. It is worth clarifying these before considering process detail further.

“Thermal efficiency” is strictly defined as the useful output energy for a given quantity of gross input heat energy and is therefore subtly different from energy conversion efficiency, which might include both heat and power as inputs and outputs.

In thermodynamics, “exergy” is defined as a measure of the potential of a system to do work. In systems energetics, exergy has been defined as entropy-free energy. In thermodynamics, the exergy B of a system with respect to a reservoir is the maximum work done by the system during a transformation which brings it into equilibrium with the reservoir. Exergy analysis is used in the field of industrial ecology as a tool to both

decrease the amount of exergy required for a process, and use available exergy more efficiently. The term was coined by Zoran Rant in 1956, but the concept was developed by J. Willard Gibbs in 1873. Rant also introduced the concept of “emergy”, which is the complementary part of the (heat) energy that cannot be converted into work.

Exergy efficiency is also called second-law efficiency because it computes the efficiency of a process taking the second law of thermodynamics into account. The energy E and exergy B balances of a process are:

$$E_{\text{input}} = E_{\text{in product}} + E_{\text{loss}}$$

and

$$B_{\text{input}} = B_{\text{in product}} + B_{\text{loss}} + B_{\text{destroyed}}$$

The efficiency η of the process may be described using the thermodynamic potentials E or B. Efficiency is the fraction of the potential that makes its way into the product.

The efficiency quoted by equipment suppliers is usually the energy conversion or first-law thermodynamic efficiency. This indicates how well the particular appliance converts one form of energy into another, but it does not indicate how the equipment compares to an alternative energy process. An example which can be used to illustrate the difference between energy conversion efficiency and exergy efficiency is the combustion of natural gas solely to heat water. While this has a high first-law efficiency, it has a low second-law efficiency, and wastes a large amount of high-temperature, high-quality energy to heat the relatively cold water. A combined heat and power system, with inherently higher exergy efficiency, uses the fuel to run a heat engine and then uses low-temperature waste heat for the water heating duty.

The new word “emergy” is a contraction of the term “embodied energy”. The need for this word arose because of an important difference in the way the two related disciplines of systems ecology and energy analysis were using the term “embodied energy”. The concept of embodied energy (*i.e.* the energy used up directly and indirectly in transformations to make a product or service) was given the name “emergy” and its unit defined as the “emjoule” or “emcalorie”. Other related properties, such as empower and ementropy also arise from the consideration of emergy. As a relatively recent innovation, there is still some ambiguity regarding its meaning and use, despite widespread use in the literature.

“Effectiveness”, generally referred to as the capability of producing an effect, is often used in relation to heat exchangers as a proxy for efficiency. The term “efficacy”, simply a measure of the ability to produce a desired amount of a desired effect, is also used in relation to efficiency. However, the focus of efficacy is the achievement of the desired effect, not the resources spent in achieving it. Based on these definitions, what is effective is not necessarily efficacious (the effect may be there, but not desired), and what is efficacious may not necessarily be efficient.

Another expression, used in the context of heat pump efficiency, is the “coefficient of performance”. The objective of a heat pump is to achieve the maximum amount of heat transfer, with the minimum amount of energy, leading to the erroneous description of its efficiency as greater than 100%.

The vapour power cycle

The vast majority of the world’s electricity is generated from power plants using the vapour power cycle. In this process, a heat source is used to heat water (although other fluids may be used) to create steam at pressure which then expands through and turns a steam turbine. The low pressure steam exhausted from the turbine is then condensed back into a liquid and returned to the heat source. In this way, the fluid passes around a cyclic process within the plant, ultimately returning to its earlier state: the vapour power cycle shown in Figure I.2. In simple terms, the process can be broken down into four stages: heat addition, expansion, heat rejection and compression.

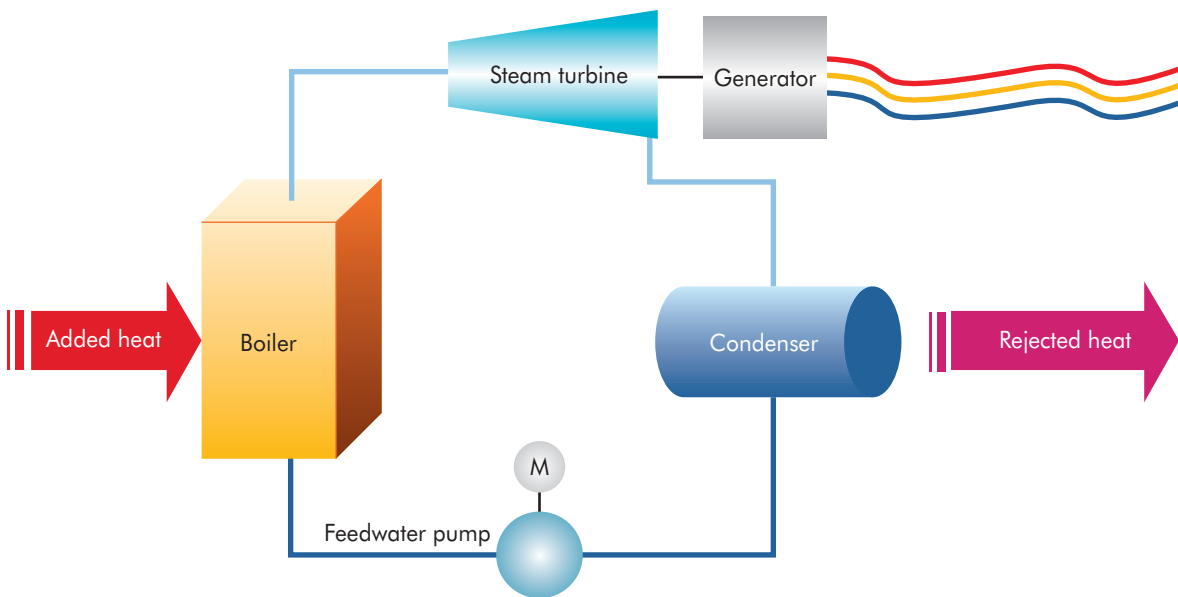
Figure I.2: Basic representation of the vapour-power cycle

Source: E.ON UK plc.

Heat addition

Heat addition is generally accomplished in a boiler where heat is transferred from a high temperature source to the working fluid. In the case of large coal-fired power plant, this source is typically a pulverised coal-fired boiler. The heat source could also be geothermal or solar energy, heat arising from a nuclear reaction, heat from a gas turbine exhaust or waste heat recovered from another process. The heat addition is usually achieved at constant pressure with the enthalpy of the fluid increasing as the temperature increases. When the fluid reaches its saturation temperature it will begin to boil and release steam, but still at constant pressure. Since a real plant operates as a continuous process, the water being boiled off as steam must be replaced with fresh liquid at the same rate as steam generation. Steam from the heat addition part of the cycle is usually cleaned of residual water droplets and superheated to a high temperature.

Expansion

The fluid in a power system boiler at start-up is initially at atmospheric pressure. However, once heat is applied and the steam generation process begins, the pressure gradually rises to the design operating pressure by restricting the exit of steam from the boiler. The air, water and cold steam expelled in the early part of the plant start-up is generally discharged to waste or a recovery vessel. Once the boiler and associated steam pipework and vessels have reached a suitable pressure and temperature, high pressure steam is admitted to the turbine through a regulator valve. On entering the turbine the steam expands, with its pressure and kinetic energy acting on the turbine blades to turn the turbine shaft and coupled electrical alternator. The turbine therefore converts the steam energy to work, which the alternator converts to electrical power for export from the plant. Steam may be taken from the turbine before it has been expanded to low pressure or it may be expanded all the way down to its saturation pressure. The majority of plants employ turbines which expand the steam down to a pressure below atmospheric pressure (vacuum conditions).

Heat rejection

Having taken energy from the heat source and done work in the turbine, the fluid must be returned to the boiler to take on more energy. Before this can be done, the fluid needs to be condensed; this is achieved by heat rejection. Heat rejection is usually achieved by cooling the low pressure steam with cold water (using seawater, river water or cooling towers) in a non-contact heat exchanger. The condensation of steam during this process results in a rapid contraction in volume as liquid forms and maintains the sub-atmospheric pressure in the condenser. The heat rejection can also be achieved by using the exhaust steam for process or space heating, providing the exhaust steam temperature and pressure are suitable.

Compression

Since the working fluid is condensed back to a liquid state, the compression part of the vapour power cycle raises the fluid pressure with no change in volume.²⁸ This is achieved with one or more high-pressure pumps to raise the liquid to a sufficient pressure to make it flow back into the boiler. The pumps must therefore operate at a discharge pressure higher than the boiler discharge steam pressure. However, the pumps do not drive the turbine – the turbine is driven by the expansion of steam which is only made possible by the addition of heat in the boiler.

Entropy and the temperature-entropy diagram

Entropy can be considered to be an indication of the *intensity* of the energy associated with fluid at a given temperature. It is a fluid property given by the fluid's heat content divided by its absolute temperature. Since the heat content can then be expressed as the product of the temperature and entropy, it is sometimes convenient to produce diagrams with temperature and entropy scales. Figure I.3 shows the saturation line for water and steam, and a constant pressure line for reference.

Figure I.3: Temperature-entropy diagram for steam and water

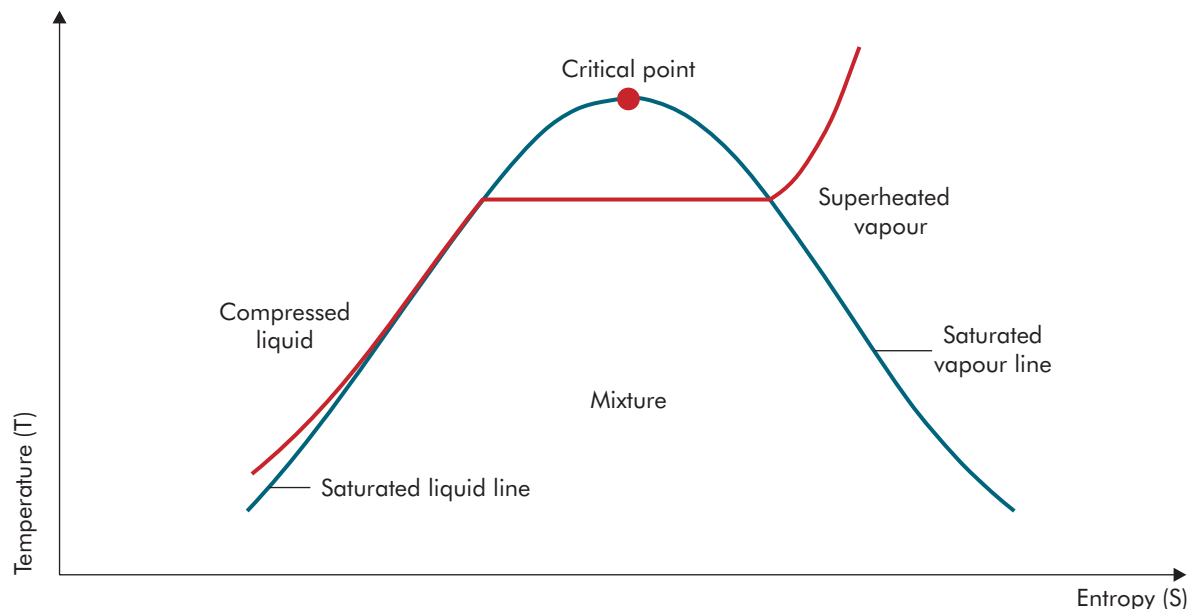

28 Crucially, raising the pressure of a liquid uses less energy than compressing a vapour; it is the change of state that allows water-steam cycles to do more useful work than would otherwise be the case.

To the left of the diagram, the fluid is water and, to the right, it is steam. Between the left and right hand sides, under the bell-shaped curve, the fluid is a mixture of water and steam. Here, it has a fixed temperature while latent heat of evaporation (or condensation) is exchanged. As the fluid temperature is raised at a fixed pressure the entropy increases until the fluid starts to boil. The temperature then stays constant while the entropy continues to rise until the fluid becomes saturated steam. At this point, the temperature begins to rise again with increasing entropy.

The Carnot cycle

Sadi Carnot recognised the energy transfer processes taking place in steam engines, and observed that there could be no work produced without the transfer of heat from a high temperature source to a lower temperature sink. Carnot noted that the quantity of work was a function of the temperature difference, with more work produced for greater temperature differences. Carnot developed the concept of a perfect, reversible cycle with no energy losses, in which heat was added, a fluid expanded doing work, heat was rejected and the fluid compressed back to the starting condition – all associated with the transfer of energy from a high-temperature source to a low-temperature sink.

Figure I.4: Carnot cycle for steam

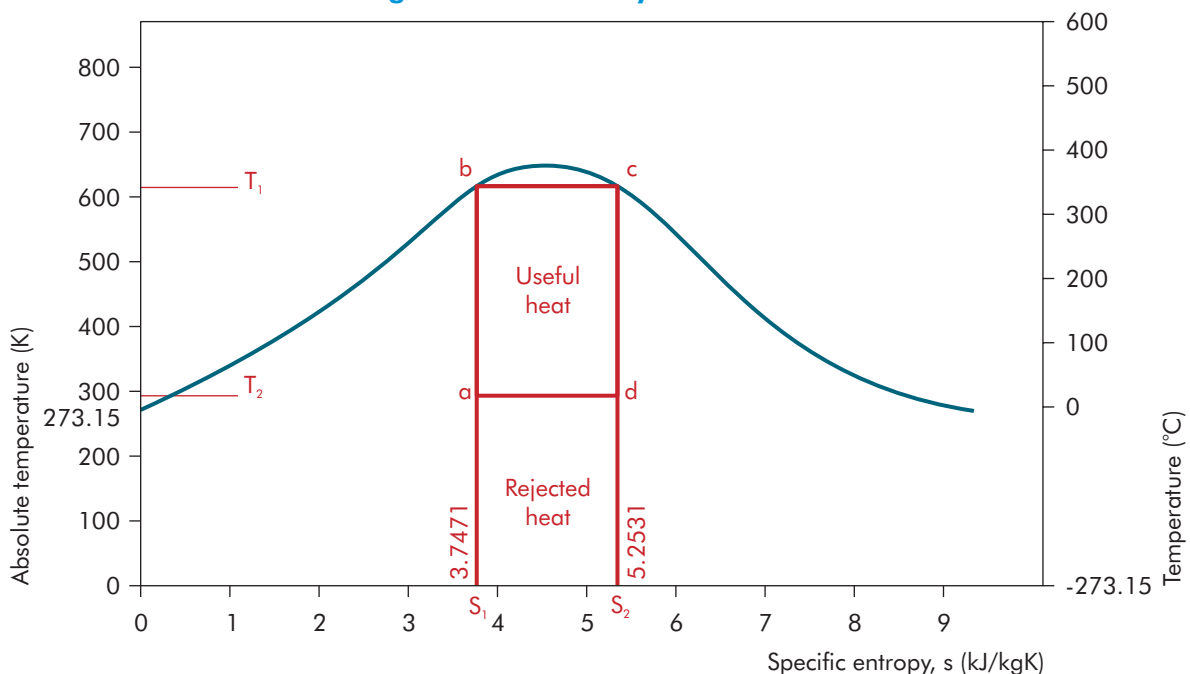

Source: White (1991). Reprinted by permission of the publisher. © Elsevier, 1991.

Figure I.4 illustrates the Carnot cycle for steam. Since heat content is the product of temperature and entropy, the areas lying under lines d-a and b-c represent quantities of heat in the fluid. The rejected heat and the useful heat are marked on the diagram, where it can be seen that the rejected heat is a large proportion of the total heat.

This simple cycle is important since it defines the most thermally efficient cycle which is possible between two temperature reservoirs. The thermal efficiency of the cycle, η_{th} can be expressed as the ratio of the net work done, W_{net} , to the heat added, Q_{in} :

$$\eta_{th} = W_{net} / Q_{in}$$

Through further analysis, it can be shown that for an ideal gas this efficiency may be expressed purely in terms of the hot and cold reservoir temperatures (T_h and T_c) as follows:

$$\eta_{th} = (T_h - T_c) / T_h$$

What this immediately suggests is that power cycles with higher temperature heat sources and lower temperature heat sinks will be more efficient. On the whole, power plants operating with higher maximum steam temperatures and lower condenser temperatures will have higher efficiencies, everything else being equal.

On this basis, a cycle operating with superheated steam at 568 °C (841 K) and a condenser pressure of 31.69 mbar absolute (*i.e.* a saturation temperature of 25 °C or 298 K) would have an ideal Carnot efficiency of 65%. This efficiency assumes that all the heat is added at the higher temperature. However, in reality, for a subcritical power plant, much of the heat is added as latent heat of evaporation across the furnace walls at a temperature corresponding to the saturation pressure of the boiler. For a boiler with an operating pressure of 169 bar, this temperature would be 352 °C (625 K), reducing the Carnot efficiency to around 52%.

Figure I.5: Schematic of a simple steam cycle for power generation and associated temperature-entropy diagram

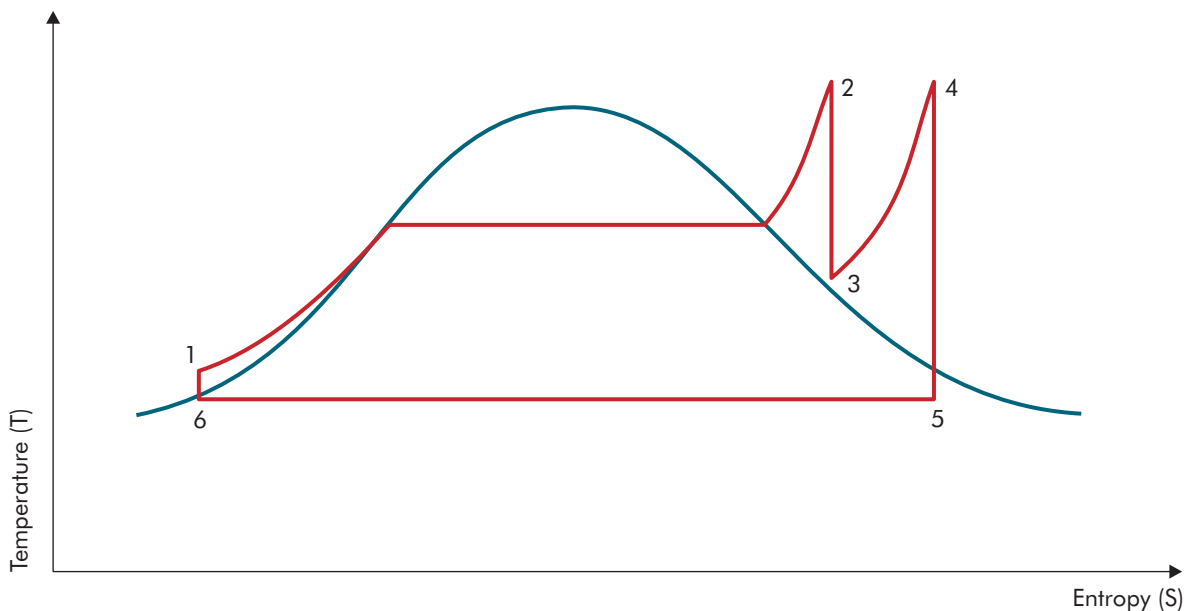
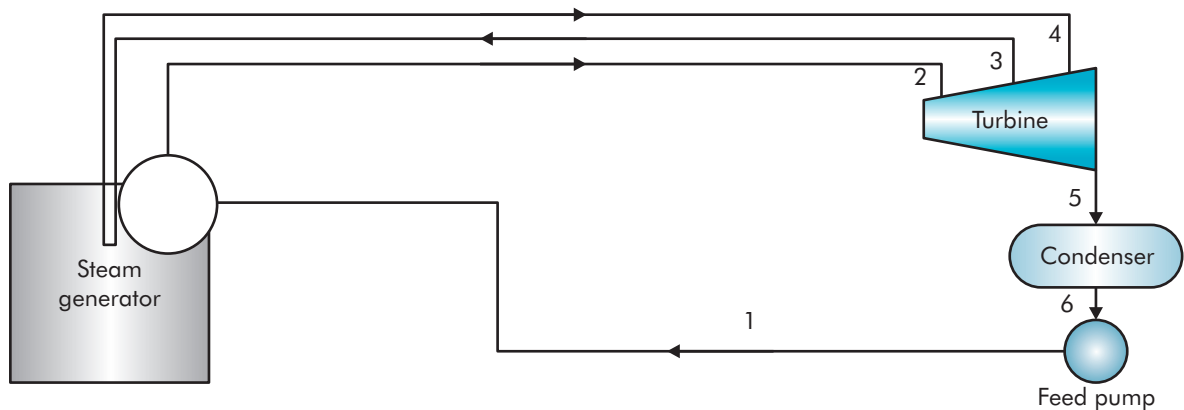
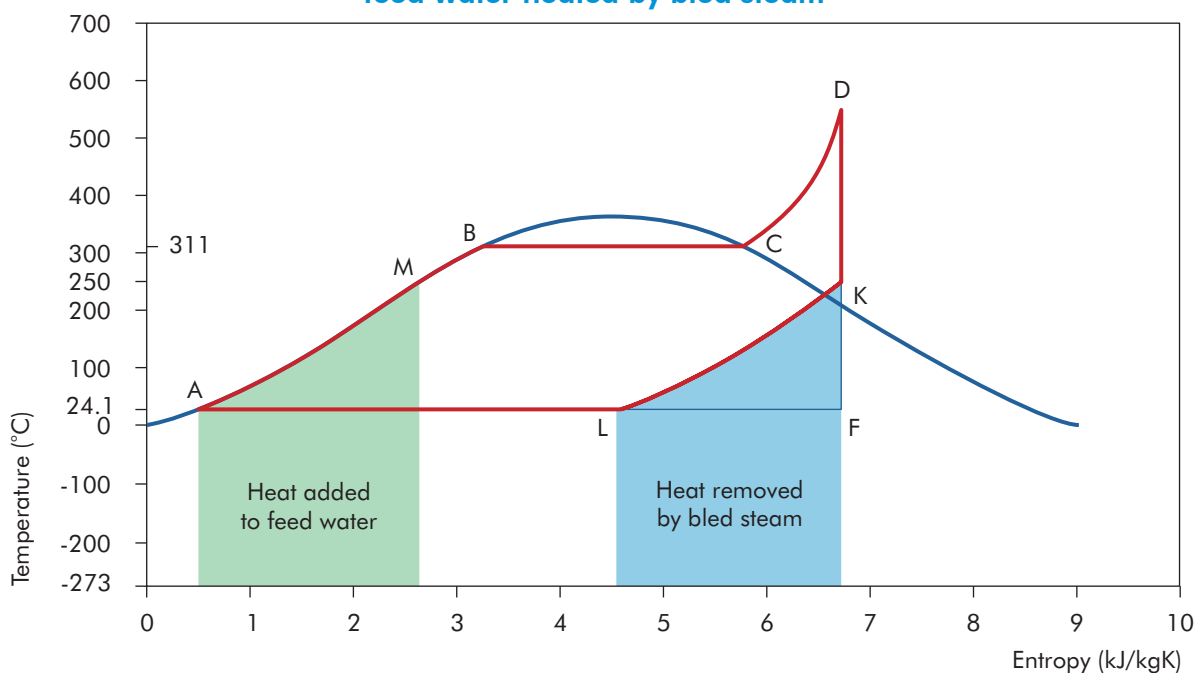

Figure I.5 shows how a simple steam cycle for power generation, including superheating and reheating, can be expressed on a temperature-entropy diagram. As with the Carnot cycle example, the useful energy is the area within the cycle envelope and the rejected energy is represented by the area falling below line 5-6. Although the Carnot cycle boundaries have been extended, and now high-temperature superheated steam is employed, a large proportion of the total heat in the cycle is still associated with rejected heat.

The line 5-6 represents the condensation of the steam in the condenser. The temperature at which this takes place is the saturation temperature within the condenser. The condenser pressure is a function of this temperature. Although the peak superheat and reheat temperatures (2 and 4) are limited by material constraints, if the line 5-6 is lowered, then more of the heat added to the cycle is useful heat. Owing to the shape of the curve, relatively small changes in this condensation temperature can bring about large changes in useful heat compared to the same temperature changes at the high-temperature end of the cycle. In fact, the total rejected heat is proportional to the absolute saturation temperature of the condenser. The significance of cooling-water temperature and condenser performance is an important aspect of understanding the efficiency of practical steam cycles.

In order to avoid the loss of useful energy through the rejection of latent heat in the condenser cooling system, and so increase overall efficiency, some of the steam can be used to pre-heat the condensed water returning to the boiler. The positions of steam off-takes and the number of feed-water heating stages are site specific. However, some plants may employ up to 12 stages of feed-water heating, using steam bled from the main turbine, before the water returns to the boiler. Figure I.6, for a subcritical cycle, shows this transfer of heat from one part of the cycle to the other, meeting part of the cycle's heat requirement to the left of the diagram. The effect of feed-water heating is therefore to reduce the width of the cycle area, and therefore both the total area and relative area of heat rejection. Feed-water heating does, however, also reduce the absolute quantity of useful heat from the cycle and adds cost and complexity to the plant. In practice, feed-water heating schemes can be quite complex with many interconnections, drains, vents, flash boxes and drains vessels. For most plant, there is the added complication of integrating a steam-driven boiler feed-water pump into the bled-steam system, along with the feed-water heating train.

Figure I.6: Temperature-entropy diagram with condensed feed water heated by bled steam



Source: Gill (1984). Reprinted by permission of the publisher. © Elsevier, 1984.

Supercritical steam cycles

Higher boiler design pressures raise the boiling temperature and the average temperature of heat addition. If the pressure is raised above water's critical pressure of 221 bar (saturation temperature 374 °C or 647 K), there is no longer any boiling at constant temperature and operation becomes "supercritical". The average temperature of heat addition, and therefore steam cycle efficiency, is increased, as in the previous cases where design pressure increased. No separation of water and steam is required, so boilers are designed without a hot reservoir or steam drum. Such boilers are known as "once-through" boilers, with no local recirculation of boiling water around the furnace tube walls. When operating at supercritical pressure, with a steam temperature exceeding 593 °C, the cycle is said to be ultra-supercritical (according to EPRI, although there is no precise definition of this term). An example of a supercritical cycle is shown in Figure I.7, with the pressure line above the critical point and no constant temperature during the heat addition.

Figure I.7: Temperature-entropy diagram of a supercritical steam cycle

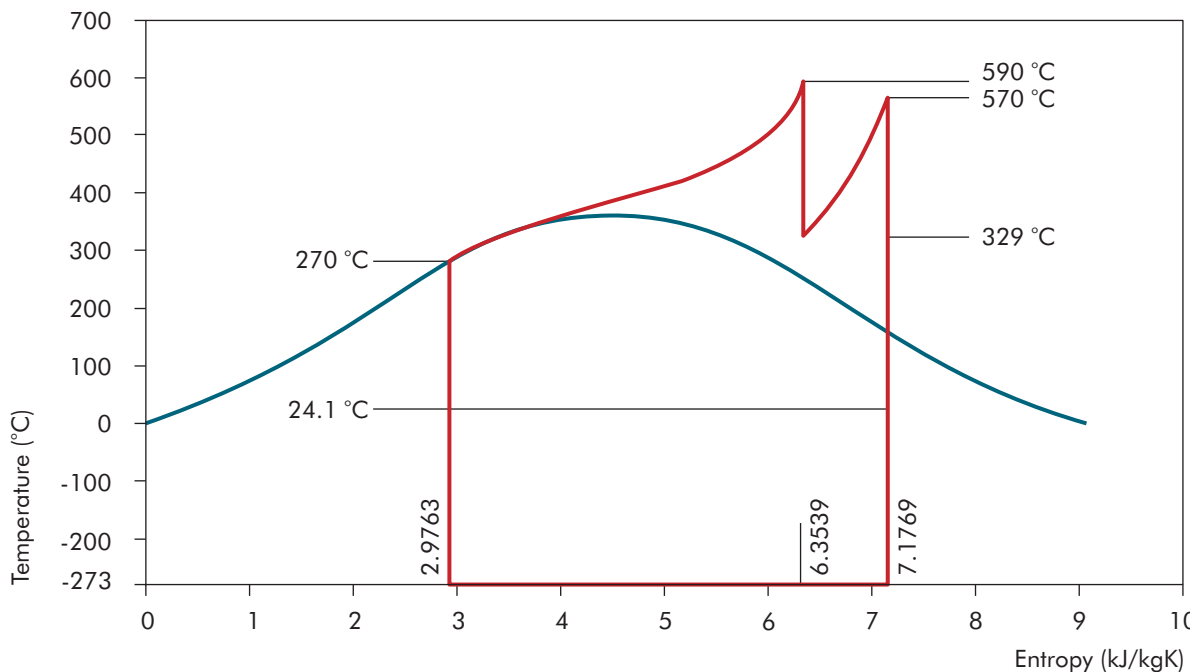

Source: Gill (1984). Reprinted by permission of the publisher. © Elsevier, 1984.

Rankine and Carnot cycle efficiencies

For practical power cycles, efficiency is usually referred to as the Rankine efficiency, which is the useful heat divided by the total heat supplied. This is calculated using the change in the enthalpy of the fluid between key points in the cycle. The equivalent Carnot efficiency can be found by considering the average temperature of heat addition and rejection, which gives the same efficiency as the Rankine calculation. This can also be compared to the hypothetical Carnot efficiency, which is the maximum conceivable efficiency which could have been achieved between the upper and lower temperatures of the cycle. Table I.1 shows a range of cycles: firstly, the basic Rankine cycle, then with the addition of superheat, superheat and reheat, superheat and feed-water heating, reheat and feed-water heating, and finally supercritical operation (with temperatures of 590/570 °C).

Table I.1: Theoretical Rankine efficiency of different cycle configurations

Rankine cycle	Efficiency, %	Average temperature of heat addition	
		K	°C
Basic	41.4	507	234
Superheat	45.8	548	275
Superheat and reheat	47.5	566	293
Superheat and feed-water heating	52.0	619	346
Superheat, reheat and feed-water heating	53.2	634	361
Supercritical pressure	56.5	688	415

Source: White (1991).

It can be seen from the table that the power cycle efficiencies are higher than those normally stated for power plant; the differences are due to the effects of real plant losses, including turbine expansion losses (isentropic expansion efficiency), throttling losses, turbine mechanical losses and generator losses. Other differences stem from a range of boiler-related losses, including heat lost in flue gases and radiation losses, and the use of works power. The vapour power cycle parameters therefore provide a foundation for estimating plant performance, but are not the only factors that influence the overall efficiency of power production.

APPENDIX II: WORKED EXAMPLE OF EFFICIENCY RECONCILIATION PROCESS

This worked example shows how a data submission and simplified calculation scheme of the type proposed in this report might work in practice.

Assume Plant A has a generating unit “A1” fired primarily with bituminous coal, for which the operator provides the annual as-run data shown in Table II.1.

Table II.1: Annual “as-run” data from operator

Data item	Quantity	Unit
Total fuel heat used (gross)	17.615	PJ
Total fuel mass consumed	656 713	t
Net electrical power export	1.543	TWh
Net water and steam energy export (where applicable)	2.880	PJ
Fuel energy export (where applicable)*	0.000	PJ
Average CO ₂ removal efficiency	0.0	%

* Some power generation processes supply fuel to other processes (e.g. fuel gas from the gasifier in an IGCC plant). This energy supply must also be accounted for in efficiency calculations.

Although the data provide no detailed breakdown of fuel qualities, the efficiency on a GCV basis can be calculated directly from the submitted fuel energy and export energy data.

$$\begin{aligned} \text{whole plant efficiency} &= (3.6 \times 1.543 + 2.880) / 17.615 \\ &= 47.9\% \text{ GCV basis} \end{aligned}$$

Efficiency on a net basis is calculated using an NCV estimated from the calculated average fuel GCV and approximate GCV:NCV ratio from Figure 3.8.

$$\begin{aligned} \text{average GCV} &= 17\,615\,000 / 656\,713 = 26.82 \text{ GJ/t} \\ \text{average NCV} &= 26.82 / 1.0440 = 25.69 \text{ GJ/t} \\ \text{whole plant efficiency} &= (3.6 \times 1.543 + 2.880) / (17.615 / 1.0440) \\ &= 50.0\% \text{ NCV basis} \end{aligned}$$

The power and heat generation efficiencies can then be expressed as:

$$\begin{aligned} \text{power generation efficiency} &= 3.6 \times 1.543 / (17.615 - 2.880) \\ &= 37.7\% \text{ GCV basis or } 39.4\% \text{ NCV basis} \\ \text{heat generation efficiency} &= 2.880 / (17.615 - 3.6 \times 1.543) \\ &= 23.9\% \text{ GCV basis or } 24.9\% \text{ NCV basis} \end{aligned}$$

Since neither CO₂ emissions data nor detailed fuel data are provided, CO₂ emissions require estimation. If we assume a C:H ratio of 15.22, since we are told the fuel is primarily bituminous coal, and a GCV for carbon of 32.808 GJ/t and for hydrogen of 141.886 GJ/t then:

$$\text{energy liberated per tonne of fuel} = 26.82 \text{ GJ/t} = 32.808 \text{ C} + 141.886 \text{ H} / 15.22$$

Where C is the mass fraction of carbon in the fuel. C in this example is therefore 63.66% (ignoring the heating value of the fuel sulphur).

Every tonne of fuel will therefore generate $44/12 \times 0.6366 = 2.33$ tCO₂, which equates to $2.33 / 26.82 = 0.0869$ tCO₂/GJ on an energy input, GCV basis (or 0.313 tCO₂/MWh). From this, the relevant CO₂ emission factors can be estimated for power, heat and overall plant output, using the efficiencies calculated above.

$$\begin{aligned} \text{CO}_2 \text{ emission per unit of total energy output} &= 0.0869 / 47.9\% = 0.181 \text{ tCO}_2/\text{GJ} \\ \text{CO}_2 \text{ emission per unit of net electrical output} &= 3.6 \times 0.0869 / 37.7\% = 0.830 \text{ tCO}_2/\text{MWh} \\ \text{CO}_2 \text{ emission per unit of net heat output} &= 0.0869 / 23.9\% = 0.364 \text{ tCO}_2/\text{GJ} \\ \text{total annual CO}_2 \text{ emissions} &= 0.0869 \times 17\,615\,000 = 1.53 \text{ MtCO}_2/\text{y} \end{aligned}$$

These calculations are summarised in Table II.2

Table II.2: Information that can be derived from the “as-run” data in Table II.1

Bulk fuel properties		
Effective GCV	26.82	GJ/t
Estimated NCV	25.69	GJ/t
Carbon dioxide emissions		
Specific emission based on total energy output	0.181	t/GJ
Specific emission based on net electrical output	0.830	t/MWh
Specific emission based on net heat output	0.364	t/GJ
Annual total emissions	1.53	Mt/year
Whole plant overall energy efficiency		
GCV basis	47.9	%
NCV basis	50.0	%
Electrical power generation efficiency (net of heat)		
GCV basis	37.7	%
NCV basis	39.4	%

If the plant was fitted with CO₂ capture equipment, then the above CO₂ emission factors would be reduced by the removal efficiency of the capture plant.

Unburned carbon in ash could be deducted from the CO₂ emissions calculation, if required, or could be taken into account using standard oxidation factors. However, in reality, such adjustments result in relatively small changes. If unburned loss is required explicitly, then the operator should record this value based on ash sampling.

The power generation efficiency, calculated on the more conventional basis of power output divided by fuel heat input, would have yielded values of:

$$\begin{aligned} \text{power generation efficiency (conventional)} &= 3.6 \times 1.543 / 17.615 \\ &= 31.5\% \text{ GCV basis or } 32.9\% \text{ NCV basis} \end{aligned}$$

$$\text{CO}_2 \text{ emission per unit of net electrical output} = 0.0869 \times 17\,615\,000 / 1\,543\,000 = 0.993 \text{ tCO}_2/\text{MWh}$$

It can be seen that the effect of utilising only a proportion of the waste heat from this plant raises the effective power generation efficiency and reduces the specific CO₂ production significantly. In fact, in this example, it could raise efficiency from what would be considered a poor value to what would be considered quite a reasonable value, with a good overall plant fuel energy utilisation level. Although the power exported is not changed by the use of some of the rejected heat, the utilisation of the primary coal energy is significantly improved.

Using the methodology required by the EU CHP Directive yields a 1 percentage point higher power generation efficiency of 38.7% GCV basis for this example because the heat supply is valued more than here (*i.e.* it is grossed up to an equivalent fuel input value for a stand-alone boiler supplying the same heat).²⁹

It is worth noting that efficiencies of between 31.5% and 50.0% could be quoted for this example plant. This is a good demonstration of why an agreed efficiency reconciliation methodology is needed.

Table II.3: Supplementary data from operator that can help detailed calculation of plant performance

Data item	Quantity	Unit
Average running load as % maximum continuous rating (MCR)	62.0	%
Average cooling-water inlet temperature	23.2	°C
Average ambient temperature	18.5	°C
SO ₂ removal efficiency	90	%
Plant mode of operation	Marginal	
Fuel 1 Type	Bituminous coal	
Contribution to total gross heat	89.7	%
Higher heating value	25.70	GJ/t
Average fuel moisture	13.9	%ar
Average fuel ash content	12.70	%ar
Average fuel volatiles content	29.60	%ar
Average fuel sulphur content	1.40	%ar
Fuel 2 Type	Heavy oil	
Contribution to total gross heat	10.3	%
Higher heating value	43.30	GJ/t
Average fuel moisture	0.2	%ar
Average fuel ash content	0.01	%ar
Average fuel volatiles content	99.20	%ar
Average fuel sulphur content	0.70	%ar
Supporting comments:		

²⁹ See footnote 8.

Where more detailed data are provided, as in Table II.3, more detailed calculations and correlations can be used to determine heating values, CO₂ emission factors and other values with more precision.

With this further operating data, it is evident that there is significant oil consumption and that the plant does not generally operate at high load. Both these factors may be due to intermittent or cyclical operation. In practice, some coal-fired plants may also fire natural gas, waste or other opportunity fuels.

Table II.4: Basic unit data required to calculate correction factors

General plant information	Quantity	Unit
Plant name	Plant A	
Country	Country C	
Location	Location L	
Plant owner	Power Co.	
Plant operator	O&M Co.	
Number of units	2	
Unit A1		
Commissioning year	1980	
Technology type	PC (subcritical)	
Design fuel type	Bituminous coal	
Unit rated power generation capacity	450	MWe (gross)
Unit maximum heat supply capacity	160	MWth
Best measured unit overall energy efficiency (GCV, net sent-out basis)	55.0	%
Best measured unit electrical efficiency (GCV, net sent-out basis)	46.0	%
Design fuel GCV	24.0	GJ/t
Design fuel moisture content	10.0	%
Design fuel ash content	12.0	%
Design fuel sulphur content	2.0	%
Cooling-water system type	Sea (once-through)	
Design main steam temperature	540	°C
Design main steam pressure	160	bar
Number of reheat stages	1	
Reheat temperature	540	°C
Flue gas desulphurisation	No	
Selective catalytic reduction	No	
Low-NOx burner/over-fire air	Yes	
Electrostatic precipitator/fabric filtration	Fabric filter	
Air separation unit	No	
CO ₂ capture	No	

It is now possible to normalise the performance data. The procedure outlined in this report requires some basic data about plant configuration. Such data would be provided on a one-off basis and then used with sets of standard corrections to adjust the reported performance to a known common basis. The general plant data provided are shown in Table II.4.

Heat consumption corrections are needed to bring the plant's reported performance in line with what would be expected for a plant fitted with FGD, SCR, LNB and OFA, ESP, with a closed-loop wet-tower cooling-

water system, operating at 80% average load under base-load conditions and with an ambient temperature equivalent to the reference plant. The associated corrections are shown in Table II.5.

Table II.5: Calculated efficiency correction factors for the “case-study” plant

	Correction factor
Particulate control	1.005
Low-NO _x burners and over-fire air	1.000
Selective catalytic reduction	0.995
Flue gas desulphurisation	0.980
CO ₂ capture and storage	1.000
Cooling-water system	0.977
Average running load (part load loss effect)	1.038
Mode of operation	1.010
Ambient temperature	1.009
Case-study plant efficiency correction to normalise	1.013

The performance of a pulverised coal-fired combustion plant is taken as a reference and corrected for the fuel properties and energy supply characteristics of the case-study plant. In the example, a supercritical pulverised coal-fired combustion reference plant with an “as-new” full-load efficiency of 46% on a NCV basis is chosen. The efficiency of this plant under normal operation, mid overhaul cycle, at 80% load factor, with allowance for moderate operational losses and deterioration, is taken to be 42.5% on a GCV basis. The reference case corrections are shown in Table II.6.

Table II.6: Efficiency correction factors for reference plant

	Correction factor
Fuel moisture	1.005
Fuel ash	1.000
Fuel sulphur	1.000
Heat export	1.460
Reference plant efficiency correction to normalise	1.467

Steam conditions are not included in the corrections. As discussed in the main report, while it is possible to estimate the impact of different steam conditions on thermal efficiency, it is not appropriate to correct for them here since they are inherent characteristics of a particular plant.

Table II.7 compares the as-run and raw data, and also shows the corrected data for the case-study and reference plants. The potential performance improvements for both CO₂ emissions and efficiency can then be determined by comparison.

In the example, it can be seen that, even though the efficiency of the plant is improved significantly through the use of some waste heat, the relative performance is still well below what could be obtained from a modern plant operating under the same conditions.

This example draws attention to the difference between potential for improvement and absolute levels of performance. The use of heat recovery is shown to boost the overall efficiency of a relatively poor plant, and therefore the efficiency of coal utilisation, while the plant still has potential to be much more efficient.

Table II.7: Overall power plant assessment summary

	As-run	Normalised as-run	Best practice	Normalised best practice	Relative Performance, %
Carbon dioxide emissions					
tCO ₂ /GJ total energy output	0.181	0.179	0.207	0.149	20.5
tCO ₂ /MWh net electrical output	0.830	0.819	0.747		
tCO ₂ /GJ net heat output	0.364	0.359	n/a		
MtCO ₂ /year	1.53				
Overall plant efficiency					
% GCV basis	47.9	48.5	42.5	59.2	-18.0
% NCV basis	50.0	50.6	44.2	61.6	
Power generation efficiency					
% GCV basis	37.7	38.2	42.5	51.1	-25.2
% NCV basis	39.4	39.9	44.2	53.1	

These calculations are relatively simple to carry out using database software for analysis and comparison. Although accuracy is not high compared to formal test protocols, the method does permit a useful and rapid comparison of performance between plants for the purposes of gauging general levels of performance and identifying outliers.

APPENDIX III: REGIONAL METHODOLOGIES AND DATA SOURCES

Australia

Australian utilities report efficiency and emissions under two separate processes – the former Australian Greenhouse Office (AGO) Generator Efficiency Standards (GES) and the National Pollutant Inventory. A summary on each scheme is provided below, specifically covering:

- treatment of fuel heating value;
- assumptions on process boundaries;
- measurement timeframe; and
- measurement units.

Utilities in Australia also report average annual plant efficiency in their annual reports. For specific component efficiency testing, Australian utilities will generally use ASME performance test codes.

AGO Generator Efficiency Standards

The GES scheme is set out in more detail below. In summary, it is currently a voluntary scheme under which generators are required to report annually on power plant efficiency performance and put in place improvement programmes to achieve best practice, given the age of each plant and the technology used. Although voluntary at this stage, the vast majority of generators have signed up to the scheme and there is an expectation that it will, in time, become mandatory.

Under the GES scheme, a set of technical guidelines have been developed which provide a methodology for reporting efficiency and greenhouse-gas emissions intensity. The guidelines can be found on the Department of the Environment, Water, Heritage and the Arts website.³⁰

In the technical guidelines, fuel heating value is defined as the fuel's gross calorific value at constant pressure, as fired, in MJ/kg. Definitions are provided for expressing power plant efficiency as generated efficiency or sent-out efficiency. The power output for generated efficiency is considered to be at the output terminals of the generators, while for sent-out efficiency, the power output is considered to be power at the generator terminals, less the auxiliary load (*i.e.* loads not driven by the turbine or other prime mover), both measured in MWh. Specific methodologies for calculating boiler, steam turbine, gas turbine and cogeneration plant efficiencies are also provided in the guidelines.

30 www.environment.gov.au/settlements/ges/publications/technical.html

The technical guidelines provide methodologies for calculating the annual greenhouse-gas emissions intensity for coal-fired power plants. Emissions intensity factors are provided under this section for carbon dioxide, methane and nitrous oxide, based on annual coal burn, carbon in fuel and carbon in ash. Consolidated greenhouse-gas emissions intensity figures are reported in kgCO₂ equivalent/MWh sent-out, on an annual basis.

GES participants are obligated to provide an annual business report to the Commonwealth government. Key performance indicators to be incorporated are:

- type of fuel (black coal, brown coal, natural gas, oil, other);
- capacity, capacity factor and output factor;
- tonnes of fuel used;
- electricity generated (MWh), electricity sent-out (MWh), electricity imported (MWh) and thermal energy produced in cogeneration (GJ);
- sent-out efficiency;
- average annual greenhouse-gas emissions intensity;
- details of improvement options undertaken and other options identified; and
- greenhouse-gas emissions target.

Reported data under the GES scheme are collated and retained in the Australian Greenhouse Gas Inventory which can be accessed freely via a government website.³¹

National Pollutant Inventory

Australia's National Pollutant Inventory (NPI) is a mandatory scheme that requires industry to report annual emissions to air, water and land. The NPI database can be accessed via the Australian government's website.³² In relation to emissions to air from power plants, a methodology is provided for power plant operators.³³ The methodology for boilers relates specifically to air pollutants (SO₂, NO_x and PM₁₀) and does not cover CO₂ emissions.

Technical Guidelines for AGO Generator Efficiency Standards

The Efficiency Standards for Power Generation measure, or Generator Efficiency Standards (GES)³⁴ as it became, was one of the key energy measures announced in the Australian Prime Minister's 1997 climate change statement, *Safeguarding the Future: Australia's Response to Climate Change*.³⁵

Generator Efficiency Standards is a best practice programme that encourages generators using fossil fuels to, "achieve movement towards best practice in the efficiency of electricity generation using fossil fuels; and deliver reductions in the greenhouse gas intensity of energy supply". This is seen as a significant initiative since over a third of Australia's greenhouse gas emissions arise from the combustion of fossil fuels for electricity generation. The standards, applying to new electricity generation projects, significant refurbishments and existing generation, were expected to achieve annual emissions savings of about 4 MtCO₂e, once businesses had implemented actions to improve performance.

In 1998, the Efficiency Standards Working Group (ESWG) was established to develop implementation options. The ESWG comprised representatives of industry, energy users, the Commonwealth and all state

31 www.ageis.greenhouse.gov.au

32 www.npi.gov.au/index.html

33 www.npi.gov.au/handbooks/approved_handbooks/pubs/boilers.pdf

34 www.environment.gov.au/settlements/ges/qa.html

35 www.pm.gov.au/media/release/1997/GREEN.cfm

and territory governments. It published a document for public consultation, *Greenhouse Mitigation Measures – Efficiency Standards for Power Generation*, in 1998.³⁶

The report of the ESWG incorporated independent technical advice that included a benchmarking study of the greenhouse-gas emissions performance of Australian fossil fuel-fired power plants. The Australian Greenhouse Office, on behalf of the ESWG, commissioned consultants to undertake analysis of best practice performance in power generation and to benchmark the current performance of fossil fuel-based power plants.

The draft ESWG report was released for public comment during November 1999, following an Efficiency Standards for Power Generation Seminar held in Canberra in July 1999 at which the broader findings of the study were discussed. In the final report, *Integrating Consultancy – Efficiency Standards for Power Generation*, released in January 2000, the working group recommended implementation of the measure on a plant-by-plant basis, covering both existing and new plants (AGO, 2000a). Following this, the Australian Greenhouse Office prepared and released another document, *Final Report: Powering into the New Millennium*, on behalf of the ESWG in February 2000. It represents the ESWG's majority views on options for implementing the Generator Efficiency Standards measure (AGO, 2000b).

The general guidelines for the GES, prepared by a group of industry experts in consultation with the Australian Greenhouse Office and other key stakeholders, set out a methodology for:

- determining best-practice efficiency for a fossil fuel-based power plant (*i.e.* electricity generation plant or combined heat and power plant), existing and new; and
- monitoring and reporting on greenhouse-gas emissions and performance against standards.

Experts drawn from power stations across Australia reviewed the draft guidelines. These experts were nominated by their peers and represented both public and private generators as well as independent power producers from the mining and minerals sector.

Following a field trial at an actual power station, the draft guidelines were released for public comment in January 2000 as part of the Government's commitment to ongoing consultation in developing the efficiency standards measure. Workshops on the guidelines were conducted during April and May 2000.

The guidelines were introduced on 1 July 2000 with the issue of Program Guidelines.³⁷ The standards apply to any power plant that uses fossil fuels, whether on-grid, off-grid or self-generating, that meets all of the following criteria:

- 30 MW electrical capacity or above;
- 50 GWh per annum electrical output or more; and
- a capacity factor of 5% or more in each of the last three years.

Where generators use both renewable sources and fossil fuels, the renewable energy is netted off. If the fossil fuel share is below any of the above thresholds, the plant will be excluded from the programme. The GES was designed not to discriminate between different classes of fossil fuels.

The second part of the GES guideline documentation, the Technical Guidelines, was issued in January 2001.³⁸ These guidelines present a calculation methodology and express greenhouse-gas performance in terms of a "greenhouse intensity" index.

A review of the 2001 version of the GES Technical Guidelines commenced in October 2004 and was undertaken by the Australian Greenhouse Office and the Department of the Environment and Heritage. It was supported by a Technical Advisory Group comprising representatives from the Australian Greenhouse

36 www.environment.gov.au/settlements/ges/publications/effstand.html

37 www.environment.gov.au/settlements/ges/publications/program_guidelines.html

38 www.environment.gov.au/settlements/ges/publications/guide_app2.html

Office, the Department of Industry, Tourism and Resources, the generation sector and industry experts. Draft Revised Technical Guidelines and a companion Discussion Paper were released to stakeholders in September 2006. Submissions were considered and the Technical Guidelines redrafted to include:

- benchmark efficiencies for new generating plants for different fuel classes;
- review of plant degradation causes and effects;
- a spreadsheet tool for calculation of a power plant's best practice performance;
- a requirement for new plants to provide operational stability reports;
- what constitutes a plant refurbishment that triggers recalculation of reference performance;
- expanded costing of options and information on the greenhouse-gas abatement calculator; and
- direction on measurement uncertainty.

The revised and current Technical Guidelines were published in December 2006 (AGO, 2006).

The goal in Australia is to encourage electricity generators to move towards best practice in energy generation and the GES covers power and combined heat and power plants, whether grid connected or not. Seventeen companies, representing the majority of Australia's medium to large energy generators, are involved in this voluntary programme having signed legally binding agreements to improve their operational efficiency and greenhouse-gas emissions performance.

Best practice performance standards for new plants have been set in terms of plant efficiency. They are currently:

- natural gas plant – 52% SO (HHV) (approximately 57.6% LHV)
- black coal plant – 42% SO (HHV) (approximately 44.5% LHV)
- brown coal plant – 31% SO (HHV) (approximately 38.1% LHV)

Where SO is sent-out electricity and HHV is higher heating value.

These standards are based on international best practice adjusted for Australian conditions (such as ambient air temperature).

Information submitted under the scheme is subject to the requirements of the *Independent Verification Guidelines – Generator Efficiency Standards* (published in December 2006) to ensure that data submitted to government are both accurate and reliable.³⁹ These are supported by a fact sheet, *Greenhouse Challenge Plus Fact Sheet 15 – An Introduction to Independent Verification for Generator Efficiency Standards*.⁴⁰

In support of the scheme, the Australian Greenhouse Office developed and made available the GES Greenhouse Intensity Calculator.⁴¹ This is an interactive spreadsheet tool for calculating and comparing the GES best practice performance range and current greenhouse intensity. The calculator accepts raw data from the participant (*e.g.* electricity output, fuel consumption and fuel properties) and incorporates the methodology of the GES Technical Guidelines. Annual reporting is achieved using a standard annual reporting pro-forma, also available electronically.⁴²

The GES Abatement Cost Calculator is designed to help GES participants carry out cost analyses in a consistent way.⁴³ The costing calculator includes a spreadsheet-based model that calculates the cost of abatement, in terms of AUD/tonne CO₂e, and a user guide.

39 www.environment.gov.au/settlements/ges/publications/iv-guidelines.html

40 www.environment.gov.au/settlements/ges/publications/pubs/fs-iv.pdf

41 www.environment.gov.au/settlements/ges/publications/intensity.html

42 www.environment.gov.au/settlements/ges/publications/annual-reporting.html

43 www.environment.gov.au/settlements/ges/publications/calculator.html

Canada

The electricity sector in Canada reviews reporting practices for criteria air contaminants and other air pollutants in a programme with Environment Canada. A multi-stakeholder work group has conducted a survey of reporting practices and identified where improvements may be made. This work was largely driven by the need for more consistent and reliable data in the National Pollutant Registry Index and followed a well-established consultation procedure.⁴⁴ The following examples come from two of Canada's provincial jurisdictions.

Alberta

Efficiency

The power plant collects weekly composite crushed coal samples from the coal conveyors and sends these to an external laboratory where higher heating values, on an "as-received" basis, and ultimate analyses are determined. The total mass input of coal delivered to each unit is measured by gravimetric coal feeders, upstream of each coal pulveriser. Total heat input is calculated monthly from the averaged coal sample analyses and the total mass input. The gross heat rate for each generating unit, based on the monthly totals of heat input (MJ) and electricity generated (MWh), is documented by the company in an internal monthly report. The year-to-date average is also reported.

Emissions

The main source of greenhouse-gas (GHG) emissions from coal-fired power plants is from fuel combustion. Other GHG sources, such as venting, flaring, fugitive, on-site transportation, waste and wastewater, vented raw gas, combustion of biomass or aerobic decomposition of waste, are either not present on site, not considered to be material or not capable of estimation because of incomplete or inaccurate data. They are therefore not included in the total GHG calculation. GHG emissions are determined by stack and then combined to give a plant total. GHG emissions are calculated using measured fuel data (including natural gas), coal and ash analyses, and emission factors.

Site specific emission factors are calculated for the CO₂ emitted from the combustion of coal, using the percentage of carbon in the coal (averaged over a year from weekly coal analyses). Recently, adjustments have been made for the percentage of carbon retained in the ash that would otherwise have been converted to CO₂. The percentage mass loss on ignition (LOI), from ash analysis, is used to determine carbon in ash. This method of calculation is adopted from the World Business Council for Sustainable Development (WBCSD) and World Resources Institute (WRI) calculation tool for direct emissions from stationary combustion (GHG Protocol, 2005).

Other greenhouse gases emitted from coal use (methane and nitrous oxide) are determined using the Canadian Standards Association (CSA) *Canadian GHG Challenge Registry Guide to Entity and Facility-Based Reporting* emission factors (unit mass of pollutant per unit mass of coal combusted) and are determined by multiplying the emission factor by the fuel input (CSA, 2007). CSA emission factors are also used to determine the greenhouse-gas emissions from natural gas combustion (which is a fairly small contribution). The total emissions from each pollutant are then multiplied by their respective global warming potentials (GWP) to determine the CO₂ equivalent emission (tCO₂e).

Reporting

Greenhouse-gas emissions are reported to the provincial and federal governments and are included in the Canadian Electricity Association's Environmental Commitment and Responsibility Program. The Environment Canada GHG emissions reporting programme specifically targets facilities in Canada that emit more than 100 000 tCO₂e annually.

44 www.ec.gc.ca/inrp-npri

Saskatchewan

Efficiency

The main method of efficiency determination is using a simplified loss-based calculation on an instantaneous basis (using on-line performance calculation software) and on a monthly basis (using an off-line spreadsheet for statistical reporting), both using plant sensor data. Gross power metering equipment of varying accuracy determines the generated, imported and exported power from the plant. In both on-line and off-line methods, turbine heat rate is calculated, based on previous test data and manufacturer's correction factors, to determine the required heat consumption of the turbine under the prevailing operating conditions to deliver the generated output measured.

The boiler efficiency is estimated using empirically developed correction factors for boiler exit gas temperatures (plant sensor), excess O₂ (plant sensor) and unburned carbon (ash analysis). Enhancements currently in progress or upcoming will see:

- upgrade of the on-line performance calculation software to one which uses a first-principles thermodynamic model, and improved data validation (2008-10);
- upgrade of all existing coal-fired units with high accuracy gross and auxiliary power metering (2009-10); and
- retrofit of missing or inaccurate plant instrumentation required to support the first-principles thermodynamic model in the on-line performance calculation software (2006-10).

Emissions

CO₂ emissions are estimated for each generation facility, based on the carbon content in fuel and the amount of fuel burned. Other greenhouse-gas emissions (CH₄ and N₂O) are estimated by fuel emission factors. Surveys to determine unit emission factors of these greenhouse gases have recently been conducted and these unit emission factors will be used for future estimates. The total emissions of each pollutant are then multiplied by their respective GWP to determine an equivalent CO₂ emission (tCO₂e).

Reporting

Each thermal power plant reports annually to Saskatchewan Environment according to the requirements under its permit to operate. Emissions of SO₂, NO_x, total particulate matter, mercury and GHG, as well as the consumption of chemicals, must all be reported as specified in the permit. The reports also provide information on quality assurance and quality control measures.

As in Alberta, greenhouse-gas emissions are reported to the provincial and federal governments and are included in the Canadian Electricity Association's Environmental Commitment and Responsibility Program.

China

Efficiency measurement and reporting methodology

The China Electricity Council has published a standard (DL/T 904-2004) for reporting technical and economic indicators of thermal power plants. Use of this standard appears to be voluntary.

The standard specifies measurement methods for boiler efficiency (through the loss method), turbo-generator efficiency and power consumption of the balance of plant or auxiliaries. Using these, the standard sets out a detailed method for calculation of plant efficiency. However, a different approach is preferred when reporting. A "standard coal" consumption, expressed in gce/kWh of net electricity supplied to the grid, is

used as a proxy for efficiency of power plants for reporting purposes. The consumption, expressed in terms of “coal equivalent”, includes consumption of all fuels in the plant: coal and any supplementary fuels, such as oil and natural gas.

Electricity supplied to the power grid is metered by each plant. Similarly, coal and supplementary fuel consumption should be determined by each plant. The coal fed into a boiler is sampled to measure its calorific value, which is then used to compute an equivalent “standard coal” quantity based on a higher heating value (HHV) of 29 271 kJ/kg (*i.e.* approximately 7 000 kcal/kg or 0.7 toe).⁴⁵ Coal is sampled at individual units for elemental analysis, measurement of moisture content and calorific value determination. Standards GB/T476, GB/T211 and GB/T213 are used for these analyses.

The reporting system, defined in the Statistics Law 1983 (revised 2009) and regulations covering the power industry, requires each power plant to submit a monthly report, including efficiency-related data for each unit, to the provincial electricity council and to their parent power company. After verifying the data, the provincial electricity council and the parent company each report monthly data to the China Electricity Council for individual power plants, rather than units. The China Electricity Council compiles these statistics and reports national and provincial data to government departments. Average figures, on a national and provincial basis, are published annually by the China Electricity Council, but information about individual companies, plants or units is not available publicly.

Shenhua Guohua Power

The reliability data, economic performance data and emissions data of power plants owned by Shenhua Guohua Power, a subsidiary of Shenhua Group, are prepared by company statisticians at each plant. After being examined and approved by plant management, they are submitted to local government economic management departments and environmental protection departments, as scheduled by the national Statistics Law.

The data required by the power industry administration branch of government are submitted on-line following the requirements of the Center of Reliability at the China Electricity Council. In addition, there are daily and monthly reports to local administration departments. Local environmental protection departments receive emissions performance information on-line from the plants, sometimes from continuous monitoring equipment.

Shenhua Guohua power plants implement the Statistics Management Measures of the company’s management and control scheme. The power industry administration appraises and compares the reliability data of generating units each year, honours the top three units, and issues annual reports to the power companies and individual power plants. All the data are collected by local administration departments and are reported to the National Statistics Bureau.

Germany

Efficiency

The efficiency of electricity production is calculated on the basis of fuel movements and stock monitoring for energy used to produce electricity. The lower heating value (LHV) is used for this calculation. Fuel samples are collected in accordance with DIN EN ISO 10715, and DIN EN ISO 6974 and DIN 51872 are used for determination of the heating value of the fuel.

⁴⁵ From private communication with two large utilities, it appears that a calorific value of 7 000 kcal/kg (29 309 kJ/kg) may be used in practice when calculating the quantity of “standard coal”.

The determined data are checked and certified by independent auditors. Statistical data are analysed by AGEBA (AG Energiebilanzen e.V. was founded in 1971 from different associations and research institutions active in the energy industry). These data are processed and made available to the public. Similar statistical data are produced by the Federal Ministry of Economics and Technology.

Individual plant data are not published. The data for conventional thermal power plants are calculated for power plant units exclusively to measure the quality of the conversion of heat into electricity. Efficiency is calculated on the basis of firing thermal input (LHV) and net electricity output. The efficiency of a power plant unit is the ratio of the electrical net output to energy supplied in the fuel. The electrical output is the output on the high-voltage side of the main transformer. The net calorific value for calculation of supplied energy from the fuel is determined on the basis of the gross calorific value, which is measured in a bomb calorimeter. Further details of the methods used to determine efficiency are contained in the VDI guideline, *Determination of Efficiencies of Conventional Power Stations* (VDI, 2000).

Emissions

Emissions data are registered in Germany according to the Thirteenth Ordinance on the Implementation of the Federal Emission Control Act, Ordinance on Large Combustion Plants and Gas Turbine Plants – 13.BImSchV of 20 July 2004 (Federal Law Gazette I p. 1717), corrected on 15 November 2004 (Federal Law Gazette I p. 2847).⁴⁶ This document contains specific information relating to:

- emission limit values for different fuels;
- requirements relating to construction and operation;
- measuring equipment methods and monitoring; and
- annual emissions reports.

CO₂ emissions are calculated on the basis of carbon intensity of the fuel used in terms of tonnes of CO₂ per unit of thermal input (tCO₂/TJ). The data provider has to provide verification that the chemical data used are correct. Uncertainties are checked with reference to the *Guide to the Expression of Uncertainty in Measurement* (ISO, Genf 1993/1995). To ensure uniformity in reporting, the values are calculated on the basis of specific emission values clearly defined by DEHSt (German Emissions Trading Authority). The representativeness of the measured and determined data is verified using national or international standards (e.g. DIN, ISO and CEN). DEHSt collects all data and emissions reports according to EU CO₂ monitoring guidelines.

India

The Central Electricity Authority (CEA) in India uses power station heat rate as a proxy for plant efficiency. Each financial year, the Authority collects the following monthly data for individual power stations from State Electricity Boards (SEBs), the National Thermal Power Corporation (NTPC) and private utilities:

- gross electricity generation;
- total coal consumption and average coal HHV; and
- oil consumption and oil HHV (for oil used during start-up and support at low loads).

These are used to calculate monthly and annual power station heat rates, which are compared with the design heat rate at 100% plant load factor. All the stations analysed use coal as the primary fuel and oil as a secondary fuel for start-up and flame stabilisation. The procedure does not take into account load changes, plant age or variation in coal quality, except for those plants operated by NTPC. It also does not provide any indication of a plant's capability under ideal operating conditions.

⁴⁶ www.bmu.de/files/english/air_pollution_control/application/pdf/13bimschv_en.pdf

Station heat rate for coal- and lignite-fired thermal power stations

Station heat rate (SHR) is an important measure for assessing the efficiency of a thermal power station or plant. It should be the endeavour of any power station to operate units as near to their design heat rate as possible. Station heat rate improvements also help in reducing pollution. The Performance Evaluation Division of CEA has devised a pro-forma to monitor various efficiency parameters of thermal power stations in India. The analysis of station heat rate parameters is split broadly into two categories: stations with a SHR of more than 10% above design (*i.e.* poor performance), and those within 10% of design (*i.e.* good performance).

The following assumptions are made for the analysis of station heat rate:

- Analysis is carried out only for those power stations where data is available covering at least nine months of operation.
- Design station heat rate is evaluated based on the design data of turbine heat rate and boiler efficiency, as submitted by the power station owner, and compared with the operating station heat rate.
- The data related to station heat rate, such as generation, fuel consumption and calorific values, are collected on a monthly basis.
- Weighted annual average gross calorific values for coal and oil are used when calculating the annual heat rate.

Heat-rate calculation methods

Two methods are used for heat rate evaluation of thermal power stations. The indirect method is an instantaneous method which is used for short-duration tests; it cannot provide annual averages. The method is a very complex, loss-based method of measuring heat rate which is generally adopted during energy audits.

The direct method of heat rate assessment is suitable for long-duration assessments, and should approximate closely to actual heat rate performance because coal consumption is averaged over a month or year. Therefore, it is standard practice to employ this method at almost all stations.

The three-step methodology adopted by the CEA for assessment of station heat rate is based on the direct method.

STEP 1: All design data such as turbine heat rate and boiler efficiency, along with a basic history of the thermal power station, are collected from the owner and unit heat rate (UHR) is evaluated with respect to unit capacities (UC) at 100% plant load factor (PLF).

$$\text{unit heat rate (UHR)} = \text{turbine heat rate (kcal/kWh)} / \text{boiler efficiency}$$

$$\text{design station heat rate} = (\text{UC}_1 \times \text{UHR}_1 + \text{UC}_2 \times \text{UHR}_2 + \dots + \text{UC}_n \times \text{UHR}_n) / (\text{UC}_1 + \text{UC}_2 + \dots + \text{UC}_n)$$

Where UC_n are unit capacities (MW) and UHR_n are unit heat rates (kcal/kWh).

STEP 2: Operating parameters, such as gross generation, total coal and oil consumption and average GCVs of the coal and oil consumed are collected from the station owner on a monthly basis. Thereafter, operating station heat rate (SHR) for each month is calculated:

$$\text{SHR} = \text{SCC (kg/kWh)} \times \text{coal GCV (kcal/kg)} + \text{SOC (litre/kWh)} \times \text{oil GCV (kcal/litre)}$$

where:

$$\text{specific coal consumption (SCC)} = \text{total monthly coal consumption (kg)} / \text{gross monthly generation (kWh)}$$

$$\text{specific oil consumption (SOC)} = \text{total monthly oil consumption (litres)} / \text{gross monthly generation (kWh)}$$

These calculations are repeated using annual averages to give the yearly SHR.

STEP 3: The operating SHR is compared to the design station heat rate. The percentage deviation gives an indication of station performance.

$$\text{heat rate deviation (\%)} = (\text{operating station heat rate} - \text{design station heat rate}) / \text{design station heat rate}$$

Italy

Utilities transmit data related to the quantity, quality and energy content of coal consumed, and emissions to national authorities, including the Ministry of Economic Development, the Ministry of the Environment, the Italian Tax Authority and the Customs Agency, and to the Regional Environment Agencies and Local Sanitary Units.

Coal quantity and quality

The coal quantity used is the customs-cleared total (classified as goods in bulk) and is ascertained at discharge through a draft survey, as provided for in the UNECE international code (UNECE, 1992).⁴⁷ The coal is sampled during discharge and these samples are used to determine coal quality. Both quantity and quality are ascertained by independent inspection companies. These data are used as the basis for determining coal use in the power plant and coal quality parameters. The daily quantity burned is determined using the indirect method, based on the energy produced and the specific consumption.

The specific consumption is determined during trial tests at the plant (reference value) and then corrected during operation based on the efficiency, which is evaluated periodically. When large differences are found, compared to the reference value, the plant components causing the difference are identified (*e.g.* turbine, mills, burners or condenser) in order to recover the original efficiency, as far as possible.

The coal quantity stocked is usually verified every six months, or on a different schedule according to the internal procedures applicable to each power company. These and other values are communicated to the authorities:

- on a monthly basis to the Ministry of Economic Development: stock quantity, input/output of coal, imported quantity at custom clearance point and geographic origin;
- on a six-monthly basis to the Ministry of Economic Development: calorific value and quantity; and
- on a yearly basis to the Customs Agency: imported quantity for single discharge point.

CO₂ emissions

The emitted CO₂ quantity is calculated in accordance with the European Union Emissions Trading Scheme Directive 2003/87/CE, adopted in Italy through a specific national decree.

The emission calculations are based on a mass balance, with different methods depending on the total annual emissions from each plant. For plants that exceed a specific emission level set out in the decree, quality parameters are determined by chemical analysis. For the remaining plants, UNFCCC data are used.

As a result, for the majority of power plants, the emission factor (tCO₂/TJ) is calculated with data from chemical laboratory analyses. Before 2005, UNFCCC data were used. Between 2005 and 2006, the use of non-qualified ISO 17025 laboratories was accepted, provided that international standard practices were used. Since 2007, it is mandatory to use ISO 17025 qualified laboratories. The relevant parameters are the calorific value and total carbon content. Also, starting from 2007, the coal oxidation factor has been determined using loss on ignition (LOI) measurements for fly-ash.

The fuel quantity used (heat and mass) for the CO₂ declaration is obtained from the sum of all coal discharges, taking into account stock variations, each calendar year. Data for each plant is verified by independent third parties, qualified by the Ministry of the Environment. The annual CO₂ declaration is formally transmitted to the Ministry before 31 March of the following year.

⁴⁷ Italy consumes only imported coal.

Japan

Efficiency measurement methodology

In thermal power stations, efficiency measurement is conducted mainly for two purposes: for periodical reporting to the regulatory authority and for evaluating the power plant condition and performance for maintenance purposes.

Reporting rules, based on the Electric Utilities Industry Law, require submission of a monthly report to the regulatory authority, including thermal efficiency data for each power station which is calculated in units of litres of heavy fuel oil equivalent per unit of electricity. This figure is used to understand how efficiently fuel is consumed in each industrial sector, and therefore efficiency is calculated on a gross basis rather than on a sent-out basis. Company average data by fuel type are made available in an annual report on the electric power industry, published by the Ministry of Economy, Trade and Industry (METI).

In addition to the monthly efficiency calculations, plant performance tests are usually conducted after periodic plant inspections. The purpose of these tests is to check the performance of main equipment or to evaluate the results of measures to improve thermal efficiency. Therefore, tests are done under the same conditions, normally at rated (100%) output.

There are two different methods of calculating efficiency, the “input-output method” and the “components method”. The first method is quite simple. Efficiency is expressed as the generated electricity measured at power metering equipment divided by the total thermal input over a certain period. Thermal input is the product of fuel consumption, measured by a belt weighing machine on the coal conveyor, and calorific value of the coal, expressed as the higher heating value (on an air-dried basis).

The second method calculates the overall plant efficiency as the product of boiler efficiency, η_b , and turbine efficiency, η_t , while accounting for plant losses:

$$\eta_p = (H_b - \sum \text{losses}) / H_b$$

Where the sum of the losses ($\sum \text{losses}$) includes the dry-gas loss, moisture in air and coal (including from coal hydrogen combustion), unburned combustible content, incomplete combustion (producing carbon monoxide), heat of ash, radiation heat loss from boiler and other losses.

The boiler heat input, H_b , is the combined heat from coal combustion and thermal input from the air heater. The turbine efficiency – the inverse of turbine heat rate – is a characteristic of the particular equipment. The overall plant efficiency, η_p is then:

$$\eta_p = \eta_b \times \eta_t \times (1 - P_{\text{loss}})$$

Where the plant loss, P_{loss} , includes pressure losses in pipes, mechanical losses and power consumed by auxiliary equipment, all expressed as a percentage of boiler heat input.

Methods of determining plant efficiency differ from one plant to another, depending on plant configuration, but the fundamental framework is generally based on Japanese Industrial Standards (JIS).

Measurement and reporting of emissions

In Japan, emissions from coal-fired power plants are regulated by the National Air Pollution Control Act, but local governments can set more stringent emission standards, depending on local air quality conditions. SO_2 is regulated on the basis of hourly volume (Nm^3/hr). The upper volume limit is set by the formula:

$$q = K \times 10^{-3} \times h_e^2$$

Where q is the volume flow (Nm^3/hr), K is a value which differs from region to region (ranging from 3.0 to 17.5) and h_c is the effective stack height. NO_x and dust standards are set in parts per million (ppm) at 6% O_2 (0 °C, 101.325 kPa) and in mg/Nm^3 at 6% O_2 respectively. Standards for a relatively new power station are 200 ppm for NO_x and 100 mg/Nm^3 for dust. Separately from national regulation, each power station usually concludes an environmental protection agreement with local government. In these agreements, emission standards are normally set rather lower than the national standard.

From April 2006, the Ministry of Environment and METI have maintained a GHG inventory system for business facilities whose GHG emissions exceed a certain level (*i.e.* consumption of heat and electricity greater than 3 million litres of oil equivalent per year). Annual GHG emissions for each power station, by category, for six kinds of greenhouse gases are calculated as tonnes of CO_2 equivalent, reported to the government and made available to the public through the GHG inventory system.

General industrial enterprises must calculate their annual GHG emissions using their fossil fuel and electricity consumption data. Electric utilities release figures for the carbon intensity of their electricity production (kgCO_2/kWh), being the weighted average of CO_2 emissions from all their power plants. These data are then used for calculations by their customers. At the moment, this inventory system is not seen as being linked to the introduction of a GHG cap and trade system. Japanese electric power companies, along with companies in other industry sectors, oppose the introduction of emissions trading and advocate contributing to the national Kyoto Protocol Target Attainment Plan by observing their own voluntary targets.

Korea

Efficiency

The energy use, and hence efficiency of electricity production, is calculated on the basis of fuel movements and stock monitoring. The higher heating value (HHV) is used for this calculation. In Korea, almost all coal used for power generation is imported, mainly from Australia, Indonesia and China. All coal must be blended to meet tight specifications before combustion in boilers. Therefore, coal samples are taken from all deliveries to the power plant stockyard and every shift (*i.e.* three times each day) from the blended coal conveyed to mills. ASTM D5865 - 10 is used for determination of the fuel heating value. The determined data are checked and certified by the Efficiency Department at each power plant. Statistical data are reported on-line to the headquarters of the respective power companies where these data are processed, but not made available to the public.

Data for conventional thermal power plants are calculated exclusively to measure the quality of the conversion of heat into electricity. The efficiency of a power plant unit is then the ratio of net electrical output to gross heat energy supplied by the fuel (HHV). Further details of the methods used to determine efficiency are contained in ASME PTC 46-1996 for the input-output method. To confirm the plant efficiencies, the secondary method, based on the ASME PTC 4.1-1964 (1991) for thermal efficiency of boilers and ASME PTC 6-2004 for thermal efficiency of steam turbines, is used to calculate the thermal efficiency of the power plant (ASME, 1991 and 2004). Individual plant data are not published.

Emissions

Emissions data are regulated in Korea according to the Clean Air Conservation Act (1 August 1990, amended 13 January 2010), Enforcement Decree (or Ordinance) of the Clean Air Conservation Act (28 January 1991, amended 26 March 2010), and Enforcement Regulation of the Clean Air Conservation Act (2 February 1991, amended 13 April 2010). The Clean Air Conservation Act regulates the emissions of air pollutants, climate- and ecosystem-changing substances, and greenhouse gases.

These laws and regulations contain specific information relating to:

- emission limit values for different fuels;
- requirements relating to the construction and operation of plants; and
- emissions measuring methods, on-line reporting and monitoring.

Emissions from coal-fired power plants, such as SO₂, NO_x and particulates, are currently reported through a tele-monitoring system; half-hourly average emissions are computed from measurements taken every five minutes at the stacks using continuous gas and particulate analysers. Statistical data include flow rate and temperature at the stack measuring points. Live air quality data is made public on a web site managed by Korea Environment Corporation on behalf of the Ministry of Environment.⁴⁸

CO₂ emissions, although not currently regulated, are calculated on the basis of fuel carbon content to establish Korea's CO₂ inventory. To ensure uniformity in reporting, the values are calculated on the basis of specific emission factors, as clearly defined by IPCC guidelines (IPCC, 1997 and 2006) and drawing on other sources of information, as required, such as the monitoring and reporting requirements of the EU Emissions Trading Scheme. The validity of the measured and determined data is verified by certified institutes, such as KEMCO (Korea Energy Management Corporation), DNV Korea and others.

Poland

Efficiency

The main sources of information relating to the efficiency of processes for energy transformation in thermal power plants are the public statistical surveys performed by the Energy Market Agency (ARE) on behalf of the Central Statistical Office (GUS), the Ministry of the Economy and the Energy Regulatory Office (URE). Data are collected through standard reporting channels, and then analysed and disseminated by the Energy Market Agency and the Central Statistical Office. National statistical surveys are adapted to meet the requirements of current EU methodologies, and the scope of surveys is being aligned to the needs of other institutions.

Commonly used indicators for calculating the efficiency of energy transformation processes include production efficiency (gross and net), fuel heat input (gross and net) and own-use power consumption. The detailed principles and structure of the indicators used are presented in a study, *Methodological Principles of Statistical Reporting and Applied Definitions for the Management of Fuels and Energy*. Information concerning the efficiency of electricity and heat production is published in *Statistics of the Polish Energy Sector* (ARE) and *Energy Efficiency* (GUS). Individual data for thermal power plants are collected, but not published because many are confidential and subject to particular protection.

Emissions

Sources for emissions data are the same public statistical surveys carried out by the Energy Market Agency for the Central Statistical Office, the Ministry of the Economy and the Energy Regulatory Office, and also inventories submitted by those entities which are obliged to according to Polish legislation (e.g. the Environmental Law, the Law on Emission Management Systems and other Polish legislation that implements the EU ETS Directive and the EU IPPC Directive).

Power plant emissions data are generally made available publicly by individual companies. Information on emissions data is also included in an annual Pollution Inventory submitted to local authorities (voivodeships) and the Chief Inspectorate for Environmental Protection (GIOS). Similar information, within the

48 www.airkorea.or.kr

framework of the EU Emissions Trading Scheme, is being collected by the National Administration of the Emissions Trading Scheme (KASHUE). CO₂ emissions data must be submitted by the end of March in the year following the reporting period. EU ETS returns are also used to compile the Polish Greenhouse Gas Inventory in an annual report for submission under the UN Framework Convention on Climate Change.

Central Statistical Office data on the emissions of all air pollutants from power plants, including those that are particularly harmful for the environment, are published in statistical yearbooks and in *Environmental Protection* in accordance with the international SNAP 97 classification of emission sources and IPCC methodology. The Ministry of the Economy and the Energy Regulatory Office require the Energy Market Agency to collect data on emissions of dust and gases from thermal power plants. These data are published in *Emissions of Environmental Pollutants from Power Plants and Commercial Combined Heat and Power Plants* and *Statistics of the Polish Energy Sector* (ARE).

Russia

Thermal plant efficiency

According to the Russian Federal Law No. 261-FZ on Energy Conservation and Improving Energy Efficiency of 2009, thermal power plants are required to carry out energy audits. These are conducted every three years by designated government bodies or accredited auditors according to the *Guidelines on Conducting Energy Audits* (approved by the Ministry of Industry and Energy in 1998) and *Guidelines on Conducting Energy Audits at Thermal Power Plants and District Heating Plants* (ПД 153-34.1-09.163-00). The latter specifically regulates the scope of work for the audit, lists energy efficiency indicators and provides a methodology for their calculation, as well as setting out a list of documents that have to be submitted to the designated government body (a report with an energy balance, an energy efficiency certificate and recommendations on improving energy efficiency). Before commissioning, the design performance for all heat and power plants is evaluated, expressed as the specific gross heat consumption for gross electricity production and as the efficiency of heat supply. In these calculations, the technical specifications for the installed equipment and data from warranty tests are used. In later efficiency audits, losses per unit of electricity produced are also taken into account. Utility plants must meet energy-performance standards that set the maximum allowable energy consumption per unit of electricity or heat produced. These are set for each individual power plant and heating boiler, as well as on an aggregate basis for enterprises engaged in the supply of heat and power to the residential and public sectors.

Fuel samples are used to obtain the data necessary to determine energy efficiency of power plants and to set energy consumption standards. These samples are obtained in accordance with the *Methodology for Quality Control of Solid, Liquid and Gaseous Fuels to Calculate Fuel Efficiency at Thermal Power Plants* (ПД 153-34.1-09.114-2001).

Measurement and reporting of emissions

The main pieces of Russian legislation on emissions from polluting sources, including power plants, are the Federal Law No. 7-FZ on Environmental Protection of 2001 and state standards on environmental quality, including GOST P 50831 which specifically concerns boiler plants. Federal law demands the implementation of technical standards for atmospheric pollution control from existing power plants. GOST P 50831 contains specific information for calculating these standards. The standards, which are reviewed every five years, are used to set up the maximum allowable and temporarily agreed emission limits that take into account the overall ecological situation and the technical capability of the equipment to limit pollutant emissions to the atmosphere. Temporary emission limits are set for individual plants and are reviewed every year. Maximum

allowable emission limits are set for five years and only change if there are any major changes in the operation of a plant. Plants have to regularly monitor whether emission standards are observed and report on actual emissions. Emissions are estimated from actual measurements or calculations and then reported to the Federal State Statistics Service (Rosstat). Specific information on setting standards and emission limits, and on monitoring and reporting of emissions from power plants can be found in: *Guidance on the Control of Atmospheric Emissions from Thermal Power Plants and District Heating Plants* (PД 153-34.0-02.306-98) and *Guidelines on Setting Standards for Air Pollutant Emissions from Thermal Power Plants and District Heating Plants* (PД 153-34.0-02.303-98).

South Africa

Measurement and reporting of efficiency

In order to manage imbalances in supply and consumption, and to provide a strategic reserve, every coal-fired power station in South Africa maintains an on-site fuel stockpile. A mass-based fuel account is maintained by each power station, and consolidated at corporate level, based on coal deliveries and consumption.

Deliveries are weighed on site to determine their mass on arrival, using road or rail weighbridges or conveyor belt weighers which are maintained to weights and measures standards and regulations. The delivered fuel is sampled according to standard procedures, and fuel quality is determined from these samples, including heat content, to ensure compliance with contractual specifications.

Coal burn is determined on a daily and monthly basis in various ways, depending on plant lay-out and availability of mass meters at the different sites. Owing to measuring uncertainties, especially with respect to the bunker levels, efficiency is not calculated and tracked on a daily basis, but is monitored on a monthly and annual basis. On a daily basis, it is of more value to monitor the indirect efficiency by considering losses. Target losses are based on design performance or test data, corrected for uncontrollable factors such as load, fuel quality and ambient conditions. A thermal efficiency monitoring programme provides for the calculation and reconciliation of both direct and indirect efficiencies. This approach adds integrity to both methods, being a self-auditing system.

A final check is performed by the regulated year-end coal stock survey which is both a volumetric and density survey. This survey is assumed to be 100% accurate and any variance of book stock from survey is corrected at the time by adjusting the burn for that particular month. The reported coal burn (and thus also the efficiency) for that month is obviously not correct since the variance has accumulated over a prolonged period, but the value for the year attains a more accurate value. This final annual coal burn is then also the figure used in annual efficiency calculations, as reported in, for example, Eskom's annual reports.

Measurement and reporting of emissions

Gaseous emissions of SO₂, CO₂ and NO₂ from coal-fired power stations are reported for each plant on the basis of total monthly and annual tonnages and specific emissions (tCO₂/GWh). Dust emissions are reported as monthly and annual tonnages, as specific emissions, and as hourly mean concentrations in mg/m³ (0 °C, 101.325 kPa) for each power station.

The reporting of SO₂ and CO₂ emissions is currently based on a calculation of the fuel sulphur and total carbon content by mass and coal consumed. Emissions from fuel oil used during start-up, shutdown and during coal mill changeovers are not reported.

Total carbon is not analysed by power station chemical laboratories. Instead, the fixed carbon is obtained by difference from the proximate analysis. However, the fixed carbon cannot be used to calculate CO₂ emissions. Therefore, composite monthly coal samples are sent to a centralised laboratory. These are analysed

to obtain ultimate (which incorporates total carbon) and proximate analyses. An annual regression curve is then calculated from a number of ultimate and proximate analyses for each power station. The regression curves are used with the weighted monthly power station proximate analyses to obtain a monthly total carbon figure for each power station. Thereafter, a CO₂ emission factor for each power station is calculated, accounting for measured carbon-in-ash values.

There is no government regulation on the release of SO₂, CO₂ and NO₂ emissions to the atmosphere. Data are supplied to the Department of Environmental Affairs and Tourism (DEAT) on a monthly and annual basis, and published in Eskom's annual reports which are available to the public.

United Kingdom

Efficiency measurement methodology

Coal-fired power plants receive and burn coal to generate electricity. In order to manage imbalances in supply and utilisation, and to provide strategic reserve, an on-site fuel stock is also maintained. Each of the power plants maintains a heat- and mass-based fuel account from data on deliveries, consumption, and changes in fuel stock.

Deliveries are usually weighed on to site to determine their mass as they arrive, using road and rail weighbridges which are maintained according to weights and measures regulations. The delivered fuel is simultaneously and representatively sampled, and from this sample the delivered heat content and fuel quality is determined. Delivered mass and heat content is therefore determined by measurement. Stock volume measurements are generally made on a monthly basis, with more extensive density and heat value surveys also being conducted, usually once at the end of each year. These enable determination of fuel stock mass and heat content directly by measurement.

Fuel consumption by the power plant can be determined directly from the delivered fuel, corrected for the change in stock. However, this can only be done monthly and is only really a good check when using the more accurate annual stock survey results. It should be noted that an overall plant efficiency is determined that incorporates the impacts of plant load factor, operating regime, physical condition of the equipment, ambient conditions and fuel quality over the assessment period.

The main method of efficiency determination carried out by plant operators is not, however, the method described above but is by using data logging and computation to estimate the actual plant efficiency directly. Accurate final power metering equipment determines the generated, imported and exported power from the plant. A turbine heat rate calculation is then made, based on previous test data and correction factors, to determine the required steam consumption of the turbo-alternator under the prevailing operating conditions to deliver the power output that has been measured. The boiler efficiency is then estimated, again based on reference data and correction factors, to estimate the quantity of fuel consumed by the boiler to deliver the steam. This predicted fuel consumption is then compared against the generated power to determine the calculated plant efficiency.

In practice, the efficiency calculated from the plant operating conditions is verified by comparing the predicted residual fuel stock (after accounting for deliveries) to the measured residual stock values. A discrepancy indicates an error in delivery, stockpile or consumption measurement and is then monitored and investigated to provide an account balance.

The benefits of this system are that any efficiency shortfalls can be identified and investigated and the comprehensive data generated in the process can be used for consumption forecasting and investment appraisal purposes. Discrepancies are typically allocated to inaccuracies in operating data. However, errors can also occur in stock and delivery measurements which are detected by fuel consumption calculations using operating data.

Such accounts traditionally incorporated checks on a weekly, monthly and annual basis. It is more common now to concentrate on the monthly account. The weekly account is rather too short term to deliver consistent results, and the annual account is of more interest in business planning. The accounts also include figures for oil used for light-up and support firing, and electric power consumed in the generation process. Monthly reports for each operating unit and the station overall are usually collated centrally within the company for analysis.

A further check on the fuel consumption of the plant can be made using belt weighers to measure the quantity of fuel passing to the boiler. Unfortunately, these weighers only measure the mass of fuel and not fuel quality, so a key part of the heat accounting equation is missing. Most UK plants fire a range of fuel qualities with variable heat content and reliance on bunker belt weighers for calculation is not considered good practice. What this does provide however is a means of monitoring trends and a second check on plant calculations. Where fuel quality does not change significantly from hour to hour, day to day or week to week, belt weighers may well be adequate for determining plant efficiency.

Short-term efficiency calculations are generally made by the plant monitoring systems in a similar manner to the heat accounting process described above. However, a large number of assumptions must be made before attempting these calculations. These assumptions introduce errors into the calculations. Even if it is assumed that these on-line calculations are accurate, the efficiency of the plant would still be seen to vary considerably during any monitoring period because of the normal short-term variations seen when operating any plant under apparently stable conditions.

Experience has indicated that coal-fired power plant efficiency cannot be measured accurately on a continuous basis by either fuel flow measurement or by real-time calculation. It is best established over either a short period (several hours) at steady state using extensive and costly test procedures, or over a long period (monthly or annually) based on averaged fuel supply data. The short-period tests are therefore used for very occasional verification checks or for contract-related guarantees, while the longer-period checks are used for normal business accounting purposes and due diligence.

Measurement and reporting of emissions

For compliance purposes, emissions from coal-fired power stations are currently regulated on the basis of annual tonnages for gaseous species such as NO_x, SO₂ and CO₂. Dust emissions reporting is based on monthly, daily and hourly average concentrations, reported in mg/m³ at 6% O₂, dry (0 °C, 101.325 kPa).

The reporting of SO₂ and CO₂ mass emissions has, until recently, been based on the sulphur and carbon contents of the fuel and on fuel consumption. NO_x emissions reporting has been based on representative emission factors for each boiler unit. Dust emissions reporting has been based on direct measurement using optical techniques that are calibrated against manual gravimetric sampling performed by an accredited test organisation to CEN or ISO standards. The stack gas flow rate, required to calculate the mass release of dust, is derived from an average stack flow value for each fuel (in m³/tonne) and this has been demonstrated to be sufficiently accurate for long-term averaging purposes.

From 1 January 2008, the EU Large Combustion Plants Directive (LCPD) requires the reporting of emission concentrations for SO₂, NO_x and dust to be based on continuous emissions monitoring systems (CEMs), excluding start-up and shutdown periods. The CEMs are subject to a rigorous quality assurance regime. For existing coal-fired plant “opted-in” to the LCPD, every monthly concentration average must be below the target emission limit values (400 mg/m³ for SO₂, 500 mg/m³ for NO_x and 50 mg/m³ for dust). These plants must also demonstrate that 97% (or 95% for NO_x) of all the 48-hour average concentrations measured across a calendar year, are below 110% of the emission limit value. To allow for measurement uncertainty, the LCPD specifies that the values of the 95% confidence interval of any single measurement shall not exceed 20% of the emission limit value, or 30% in the case of dust. In the United Kingdom, this is implemented as a percentage adjustment to the hourly average measured concentration.

For those existing coal-fired plants “opted-out” of the LCPD, so with a limited remaining lifetime of 20 000 operating hours, compliance will be based on annual average concentrations of SO₂ and NO_x (expressed in t/GWh) and annual tonnage limits, to ensure that the same level of environmental protection is achieved overall. However, dust compliance will continue to be based on monthly and short-term concentration averages. Stack gas flow rate (short-term averages) will be calculated from the power station’s electrical output and overall thermal efficiency for both opted-in and opted-out plants.

From 2005 onwards, the annual mass emissions of CO₂ from each combustion plant have been reported under the EU Emissions Trading Scheme (EU ETS). This is based on a fuel-burn approach, which is considered to be more accurate than the combined measurement of stack gas CO₂ concentration and stack gas flow rate. Fuel consumption (tonnes) is based on fiscal metering (weighbridges, *etc.*), combined with fuel stock changes. The carbon content of the fuel is derived from ultimate or proximate fuel analysis (based on representative fuel sampling), giving a CO₂ emission factor ($t\text{CO}_2/t_{\text{fuel}}$) and hence the mass release of CO₂.

The EU ETS requires that releases are reported during all operation, including start-ups and shutdowns. Since only released CO₂ is regulated, a correction for fuel carbon retained in the boiler ash is permissible by applying an oxidation factor. The oxidation factor takes into account the ash arisings and their measured unburned carbon content. The heat content and quantity of biomass are reported although the emission factor for biomass fuels is zero, reflecting their more favourable environmental impact.

The annual EU ETS return is for the whole site, so is not unit specific. For most plants this is in accordance with the definition of a plant under the Large Combustion Plants Directive.

Power companies must supply statistics to the Environment Agency (a non-departmental public body accountable to Parliament through the Secretary of State for Environment, Food and Rural Affairs) for emissions of pollutants from their sites in the form of a pollution inventory (PI). This inventory lists all releases and is publicly available for each site.⁴⁹ Unlike the ETS figures, which are corrected for carbon neutral fuels like biomass, the PI returns show total CO₂ emissions.

Sources of efficiency and emissions data

Statistics related to output and consumption are used on-site and within the power company’s own businesses, but are also submitted as summaries to the UK Department of Energy and Climate Change (DECC), which compiles and publishes national statistics for fuel and energy.

The published statistics include all significant fuel movements and stocks, power generation and the implied efficiency of the different power generation plant types, together with their capacity and utilisation. Efficiency is calculated on a gross calorific value basis, using assumed average calorific values for different fuel types based on statistical data together with the reported consumption of fuel. The main benefit of these data is that they represent overall “as-run” generation efficiencies for the sector at national level to a degree of accuracy which would be difficult to achieve from independent estimates and assumptions made for individual units and power stations.

Commercial confidentiality precludes output and efficiency data being made publicly available for individual power plants or even individual power companies. Data provided to DECC by energy companies are submitted on a company basis and are then merged together into business sectors before publication. This is sufficient to determine the overall national average load factor and efficiency of coal-fired stations.

Power plant emissions data are generally made available publicly by individual companies as part of corporate social responsibility and environmental impact initiatives. Similar information is also included in annual pollution inventory returns to the Environment Agency and in returns to the EU Emissions Trading Scheme. CO₂ emissions data must be submitted by the end of the March in the year following the reporting

⁴⁹ www.environment-agency.gov.uk/homeandleisure/default.aspx

period. The EU ETS returns are also used to compile the UK greenhouse-gas inventory in the annual report for submission under the UN Framework Convention on Climate Change prepared by the National Environmental Technology Centre (NETCEN).

United States

US firms operating coal-fired plants may be either public utilities or private companies. Private companies tend to use ASME performance test codes for initial plant performance assessment purposes, followed by the use of their own internal data processing and reporting methodologies to track fleet and unit performance on an ongoing basis. Design heat rate or efficiency is sometimes available, but actual heat rate is not typically shared for competitive reasons.

Regulated public utilities are required by the Federal Energy Regulatory Commission (FERC) to report a standard set of information. The manner used to calculate these data is not prescribed in detail. Firms do not have to run a performance test to develop the information and it is not currently used for regulation. While ASME performance test codes are used by public utilities, they are not used for routine purposes owing to their cost and complexity.

In the United States there are two jurisdictions that have an interest in the efficiency of and emissions from coal-fired power plants: the federal government and the state government. Each of the fifty individual state governments has its own requirements but, as a group, they are very similar and generally have reporting requirements that mimic the federal requirements or use the federal data directly.

Efficiency measurement methodology

A generating unit's efficiency is generally reported as a heat rate (HR). This describes the amount of energy, expressed in British thermal units (Btu), necessary to provide one kilowatt-hour of electricity to the grid. It is inversely related to efficiency by a constant ($HR = 3\,412 \text{ Btu/kWh} / \% \text{ efficiency}$). The heat rate is an average operating value over a period of time, usually a month or a year; start-up fuel, part-load and off-design operation, physical condition of the equipment, ambient conditions and fuel quality all have an influence. Heat input is always based on the fuel's higher heating value (HHV) for coal-fired generating units and electricity output is on a net basis.

There are two methods commonly used for heat rate reporting for thermal power stations. The most common is the direct method, known as input/output (I/O). The heat input to the generating unit, being the product of coal tonnage and heating value, is measured directly as is the electricity output to the grid. The coal tonnage can be measured by gravimetric feeders or conveyor belt scales.

The indirect method, known as output/loss (O/L), is a calculation of heat rate based on ASME steam generator efficiency test methodology (ASME, 1991). Steam generator losses are determined and the heat transferred to the turbine cycle is measured to calculate steam generator efficiency. The total heat input to the unit is the turbine heat input divided by the steam generator efficiency. The electricity output to the grid is measured directly.

Coal-fired plants receive deliveries of coal by train, barge, conveyor and truck. The deliveries are often weighed and sampled for heat content and other qualities not directly related to the heat rate calculation. The measurements can be done on site by the station operator or at the point of origin by the vendor. Truck, rail and conveyor belt scales are used as well as barge draft measurement, which uses the displacement of the barge to determine the mass of coal on board. Scales are usually maintained to standards published by the National Institute of Standards and Technology (NIST) and sometimes certified to those standards by the states. Maintenance and calibration of these scales are usually defined in the contractual agreement between the supplier and operator, but must meet state requirements as a minimum.

On the consumed side, coal is either weighed by a conveyor belt scale, a gravimetric feeder or estimated by indirect means. The belt scale measurement is not suitable for short-term calculations because it delivers coal to a bunker rather than directly to the steam generator. Since coal is treated as “consumed” when it passes over the scale, accuracy is dependant on an estimate of the change in the amount of coal held in the bunker. The relative impact of this error is reduced as the measurement interval increases. Using gravimetric feeders eliminates this issue, so operators can estimate real-time heat rate as well as the operating heat rate over an interval. The measurement error depends on the number of feeders and their calibration characteristics, and could be better or worse than a belt scale. Plant operators often use the O/L method as a check of the I/O method and for real-time heat rate, even if they are not using it for reporting purposes.

In order to manage imbalances in received and consumed coal, and to provide an operating reserve, an on-site coal storage pile is maintained. Each power station maintains a fuel account based on deliveries, consumption and change of coal pile inventory. This can be either mass or heat content (Btu) based. Annual inventories are performed on the coal pile to reconcile the received and consumed quantities with the quantity stocked. Usually this results in an adjustment to the consumed quantity, based on the assumption that the plant received what it paid for and that the coal inventory is correct. Plants with known scale issues or large adjustments may repeat the inventory one or more times during the year.

Clean Air Act Amendments: Title IV regulations and compliance

The Title IV Acid Rain Program rules were developed in response to the Clean Air Act Amendments (CAAA) of 1990. Subsequent to the CAAA, state environmental agencies were required to promulgate rules implementing the federal acid rain rules.

Phase I of the acid rain reduction programme went into effect in 1995 and Phase II of the programme went into effect in 2000. Phase I affected 263 units at 110 mostly coal-burning electric utility plants located in 21 Eastern and Midwestern states. An additional 182 units joined Phase I of the programme as substitution or compensating units, bringing the total Phase I affected units to 445. Phase II tightened the annual emissions limits imposed on these large, higher emitting plants and also set restrictions on smaller, cleaner plants fired by coal, oil and natural gas, encompassing over 2 000 units in all. The programme affects existing utility units serving generators with an output capacity of greater than 25 MW and all new utility units.

Emissions of SO₂, NO_x and CO₂ must be monitored and reported quarterly, and are publicly available.

Sources of efficiency and emissions data

Statistics related to heat rate are used by the operator to monitor generating unit performance. They are submitted to state and federal jurisdictions on a unit basis, but public availability is restricted or the data aggregated for reasons of commercial confidentiality.

The Energy Information Administration (EIA) of the Department of Energy (DOE) is required to publish, and otherwise make available to the public, high-quality statistical data that reflect national electric supply and demand activity as accurately as possible. Data are collected on a unit basis. The EIA collects heat-rate data with the following forms and maintains a database as well as issuing its own reports such as *Electric Power Monthly* and *Electric Power Annual*.⁵⁰

The EIA-860 *Annual Electric Generator Report* collects annual data on existing power plants of electric power producers and their five-year plans for constructing new units and modifying and retiring units. Tested, full-load heat rate is collected, rather than operational heat rate. These data will be protected and will not be disclosed to the public.

⁵⁰ www.eia.doe.gov/cneaf/electricity/forms/datamatrix.html

The EIA-906 *Power Plant Report* collects data from electric generators on net generation; energy source consumption; end-of-month stocks of coal and petroleum; and useful thermal output from co-generators for each plant by prime mover and energy source combination. Heat rate is not collected directly but can be calculated from net generation, fuel consumed and heat content, which are collected. This information is not considered confidential and may be publicly released in identifiable form.

Completion of the following form is a requirement for those subject to the jurisdiction of the Federal Energy Regulatory Commission (FERC).

The FERC-1 *Annual Report of Major Electric Utilities, Licensees, and Others* collects financial and operational data from regulated electric utilities. This form contains a specific heat-rate data point but it is plant rather than unit based. It is also considered to be a non-confidential public use form.

The US Environmental Protection Agency (EPA) tracks CO₂ emissions (and gross power output) from US power plants via quarterly data inputs from the plants and makes this data public.⁵¹

At the state level, each state has its own reports but the data are often taken from the EIA directly or closely duplicates it. The heat-rate data are almost always treated as confidential. Cases before the state public utility commissions are also a potential source of heat-rate data given their public nature. However, it is often requested that these data be withheld from the public for reasons of commercial confidentiality.

51 <http://camddataandmaps.epa.gov/gdm/index.cfm?fuseaction=emissions.wizard>



International
Energy Agency

Online bookshop

Buy IEA publications
online:

www.iea.org/books

PDF versions available
at 20% discount

Books published before January 2009
- except statistics publications -
are freely available in pdf

International Energy Agency • 9 rue de la Fédération • 75739 Paris Cedex 15, France

iea

Tel: +33 (0)1 40 57 66 90

E-mail:
books@iea.org